

The DNA of SKY implant systems



SKY - Leading in immediate restoration

Our
MISSION

“To provide better dental care for people our qualified team develop, produce and distribute pioneering end to end solutions.

We support and advise our customers on the safe and successful use of our therapy solutions.”



W O R L D W I D E

& *Our*
VISION

*“bredent complete
solutions are available
Worldwide – for as
many customers and
patients as possible.”*

TRIM – Tissue Related Implant Management

4

The bredent group implant philosophy

copa
SKY 

- Immediate implantation
- Immediate restoration
- Disinfection at point of extraction
- Shock absorption
- Implant surface
- Implant position
- Implant material
- Cleanliness

Preservation
Hard tissue

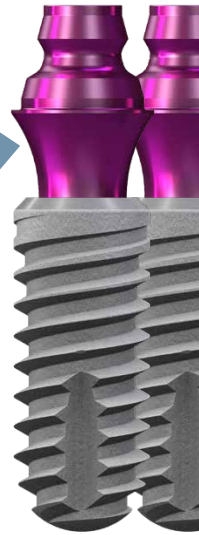

white
SKY
IMPLANT SYSTEM



Biomechanics

- Form fit
- Passive fit
- Precise impression
- Physiological materials
- Avoiding extensions
- High-quality materials



mini²
SKY 

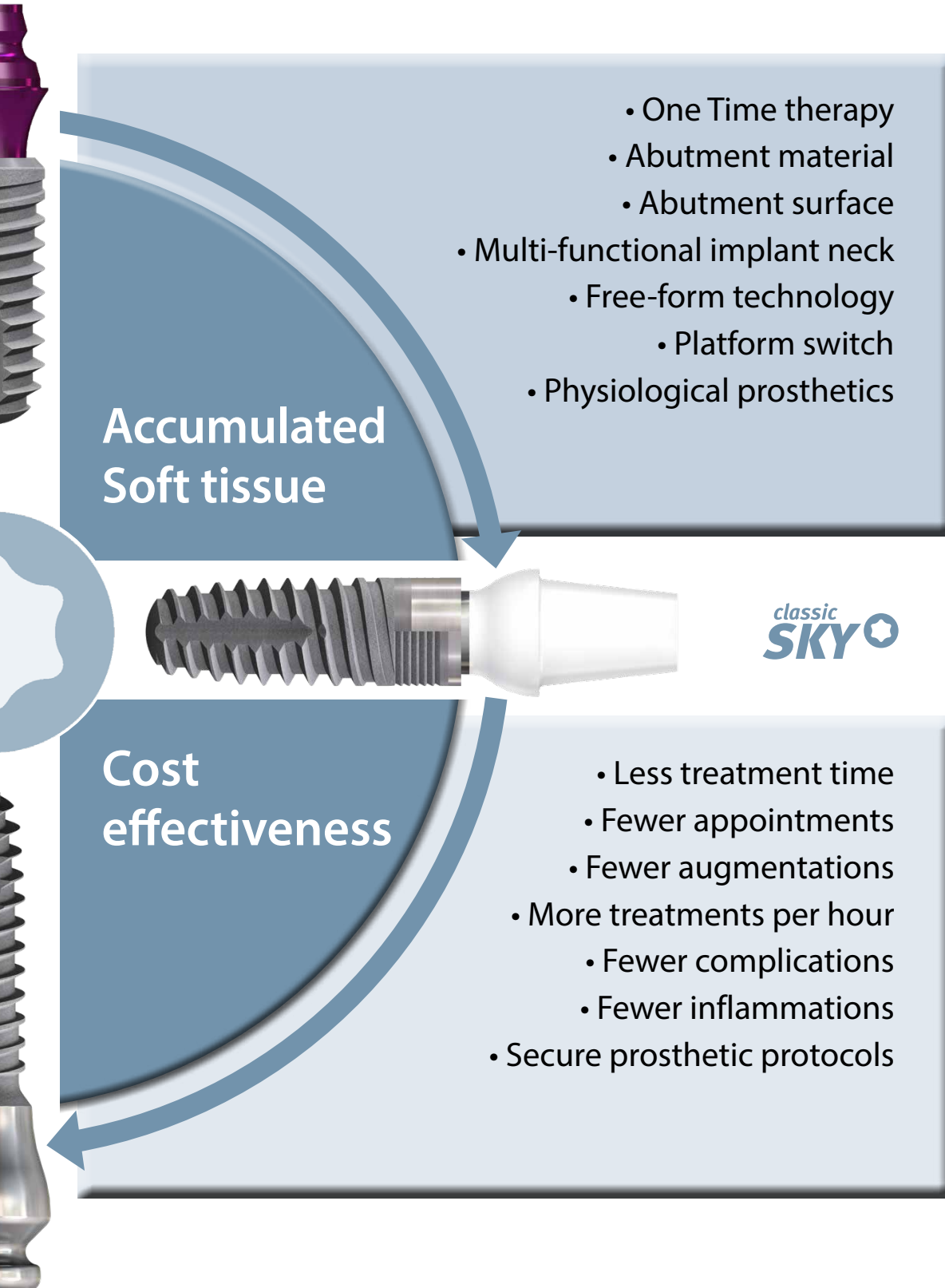

TRIM – Tissue Related Implant Management

6

One for all - for free hand or guided surgery

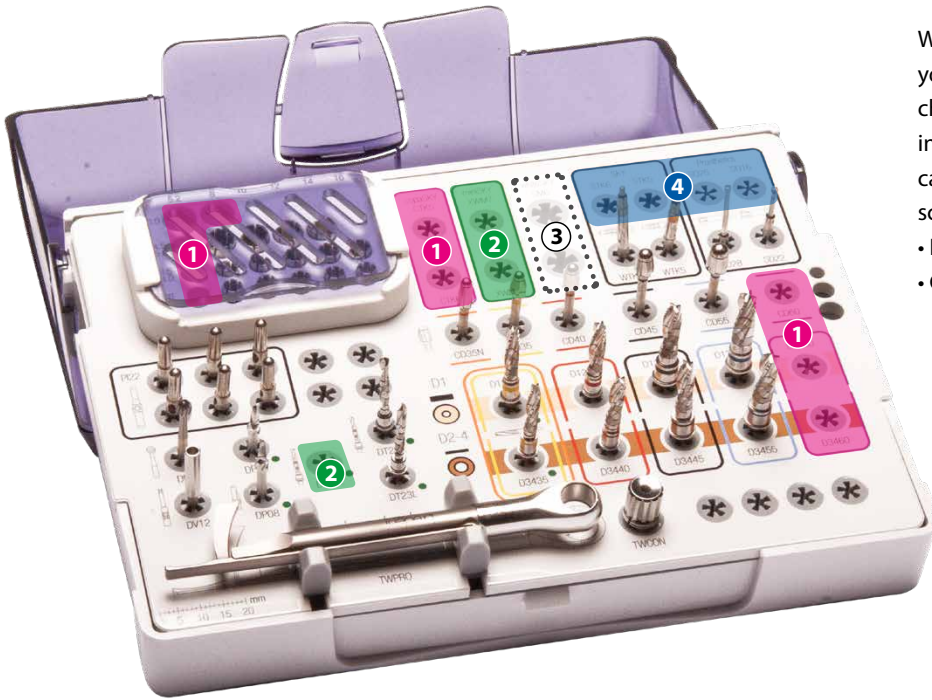

With one surgical tray, SKY allows you to place all implants, i.e. you can change the implant system intraoperatively if you see that the clinical situation deviates from the planned scenario. This applies to both:

- Free hand surgery – SKY OT 100
- Guided surgery - SKY proguide





- **More than 1.25 million inserted implants**
- **More than 30% immediately restored**
- **Every 11 minutes a SKY implant is immediately restored**

TRIM – Tissue Related Implant Management

8

The right implant for every bone situation

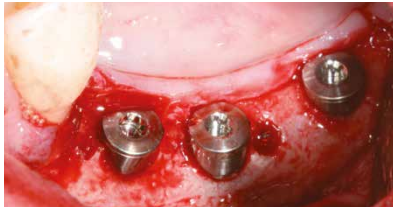

SKY classic

The long multi-functional neck is suitable for supracrestal implant position.



blueSKY / narrowSKY

The short multifunctional neck is ideal for positioning the implants at bone level and compensates for slight bone irregularities.



miniSKY

The narrow miniSKY platform is set at bone level and is optimised for narrow bone ridges.

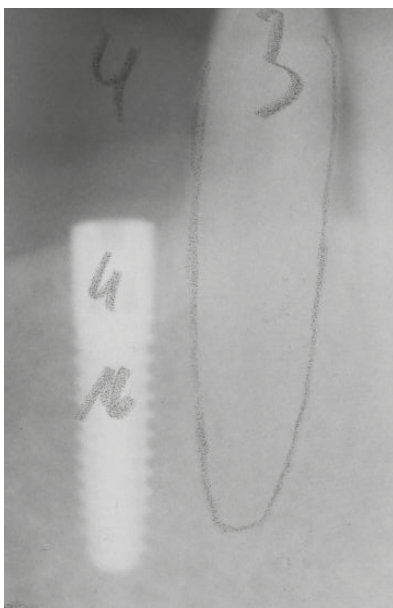



copaSKY ultrashort

The large back taper is covered with bone chips, resulting in subcrestal implant positioning. The etched surface is also suitable for contact with soft tissue.



copaSKY

The back taper is covered with bone chips, creating a subcrestal implant position. Bone chips can also be placed on top of the cover screw.



whiteSKY

The one-piece implant is placed in the bone up to the limit of the rough surface.

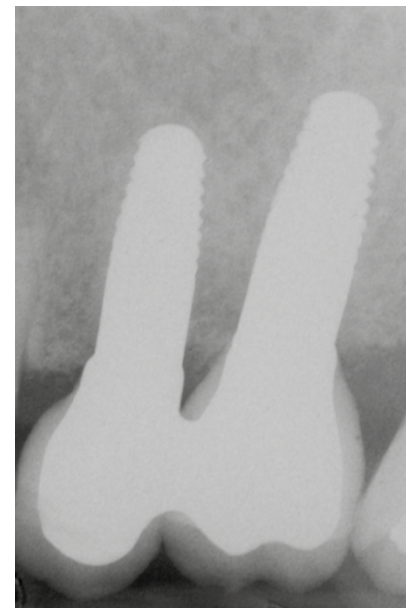
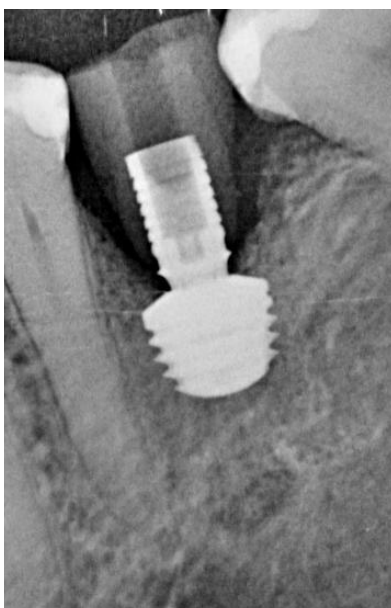

TRIM – Tissue Related Implant Management

osseo-connect-surface (ocs)[®]

The multi-functional implant neck in combination with abutment material, design and surface is an essential combination.

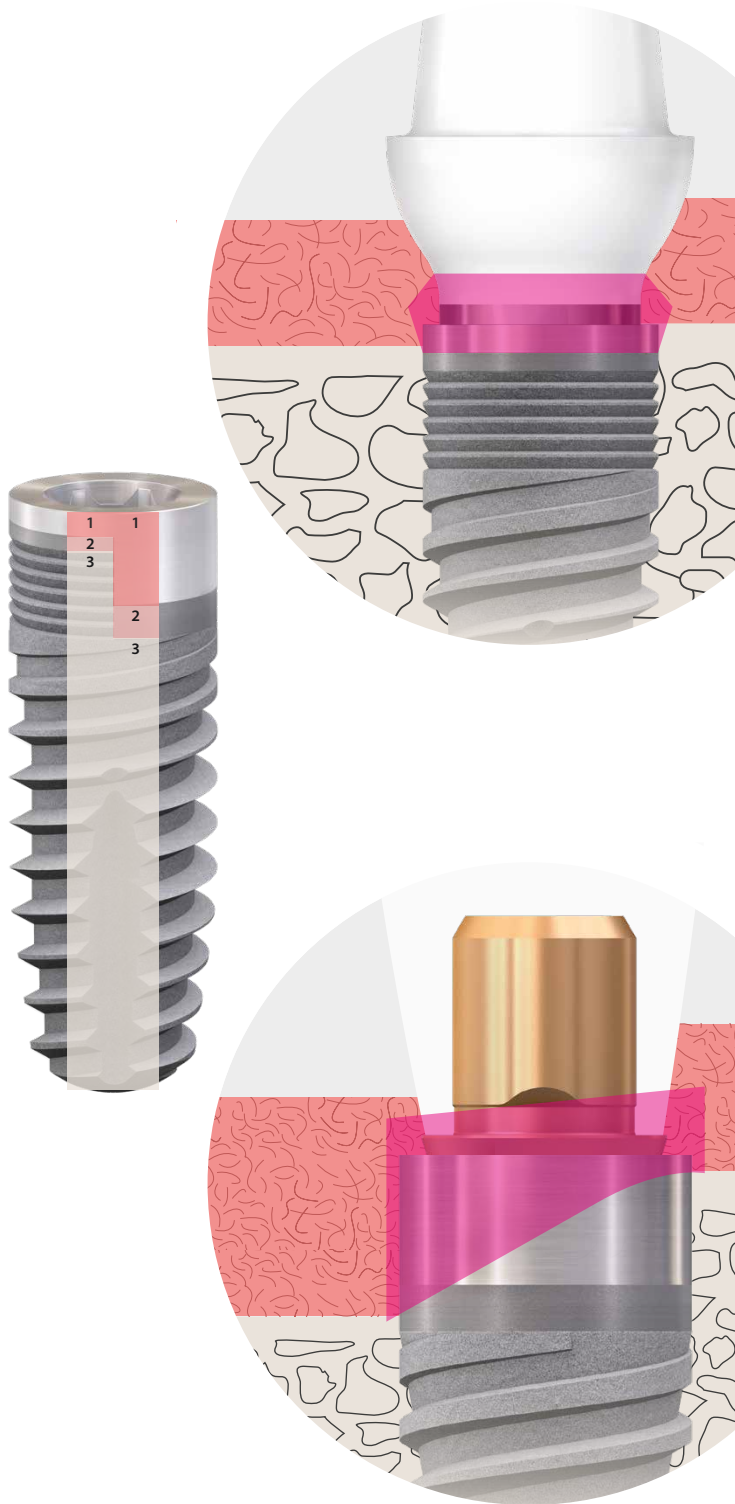

Epithelium

Ra ~ 0.07 µm



Connective tissue

Ra ~ 0.36 µm



Bone

Ra ~ 2.2 µm



Due to the small dimensions, only 2 surfaces

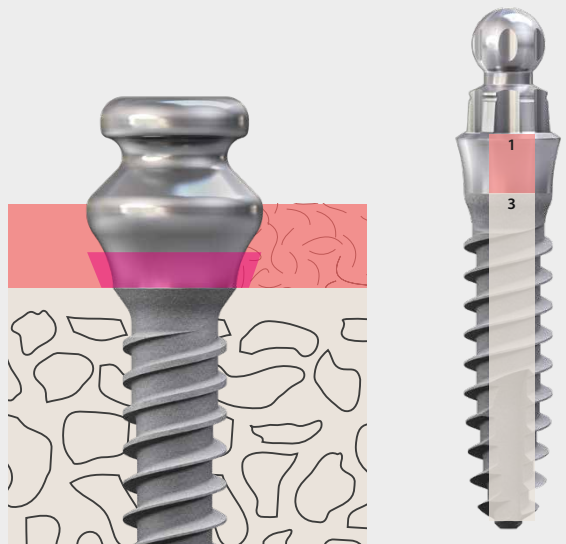

Gingival seal comprises of attached soft tissue

This combination is a prerequisite for the formation of a gingival seal that protects the implant. One Time therapy supports this process.

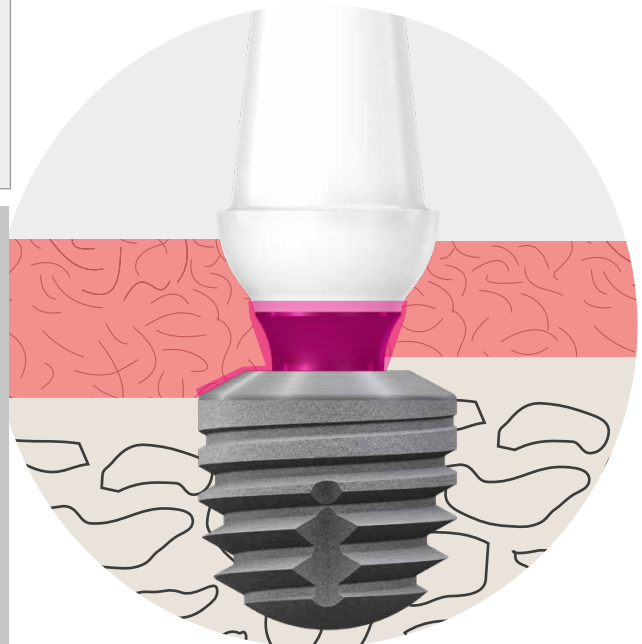
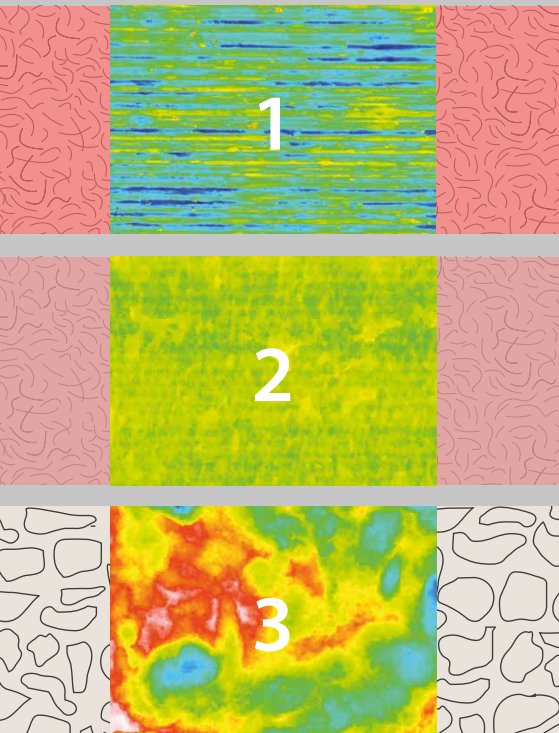

www.literatur-sky-dna.info

One Time therapy is integrated into the one-piece-implants and the formation of the soft tissue seal is guaranteed.

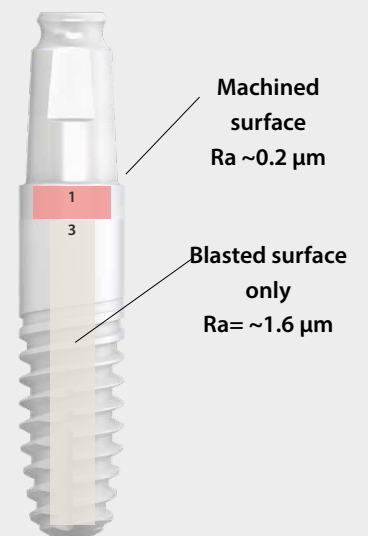
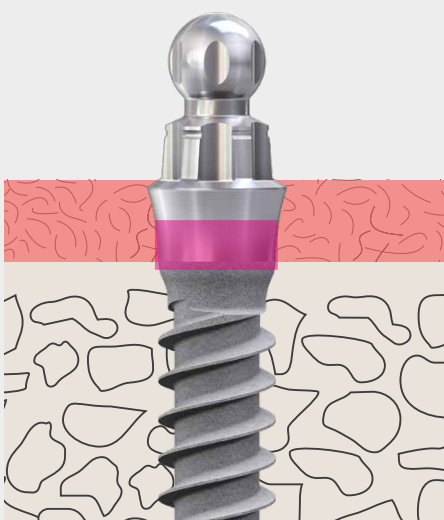

TRIM – Tissue Related Implant Management

Smooth polished or with defined roughness?

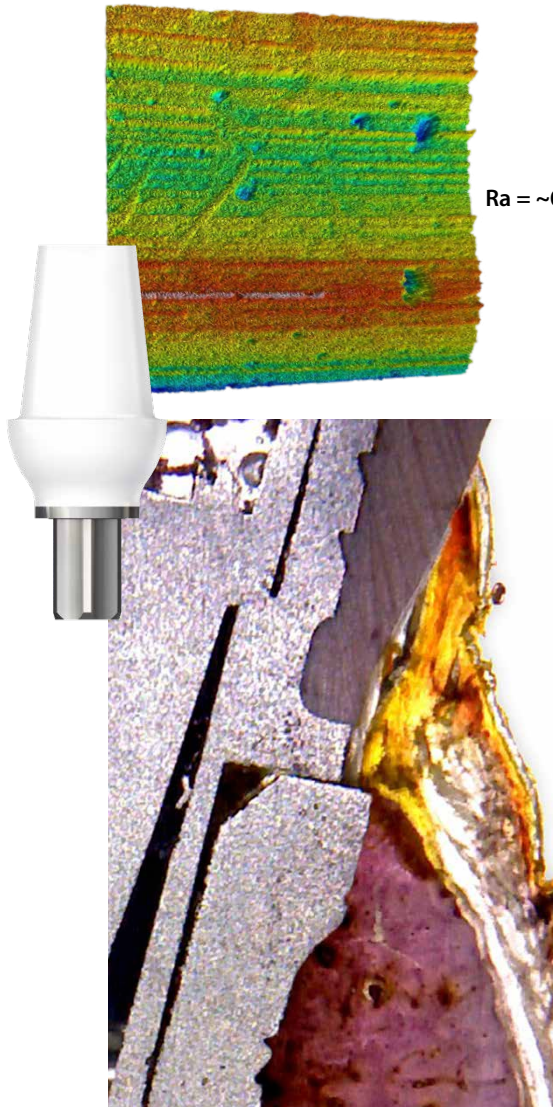

The scientific studies with BioHPP SKY elegance abutments were used with a Ra value of 0.305 µm. The surface morphology in combination with the high bio compatibility of the surface of BioHPP contributes to the excellent attachment of the soft tissue.

Surface topography of abutments individually manufactured or processed in the laboratory should be specifically developed in the submucosal region. The aim is to achieve a defined roughness of 0.21 to 0.42 µm. From the aforementioned scientific studies on BioHPP and others it can be deduced that in this region the bacteria and plaque accumulation on the surface is low and at the same time an accumulation of fibroblasts is supported.

Traffic light system according to Gehrke/Fischer:

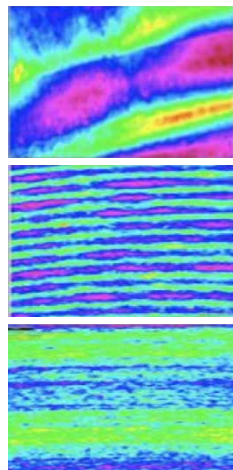
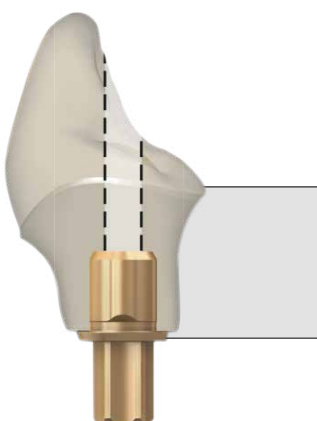

rough: > 0.42 µm
(red: increased risk of plaque accumulation)

medium rough: 0.21 - 0.42 µm
(green: optimal adhesion of fibroblasts)

smooth: < 0.2 µm
(yellow: reduced adhesion of fibroblasts)

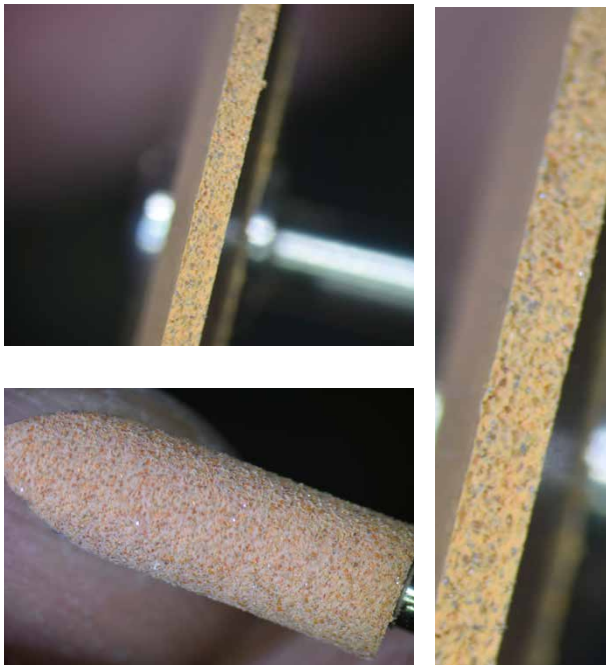

Fibro+ makes the difference

- The integrated grinding wheels achieve a defined surface roughness of approx. 0.35 µm when polishing with Fibro+. This supports the attachment of fibroblasts.
- In addition, Fibro+ polishing cleans the surface of components manufactured or processed in the laboratory in the sensitive sulcus region so that possible residues are removed from laboratory production or the machining process.
- Bonding in the laboratory safely removes cement residues and eliminates the risk of periimplantitis from cement.
- The defined surface area and improved cleanliness reduce the risk of complications and improved fibroblast accumulation also reduces plaque formation in the long term.
- All abutments manufactured or customised in the laboratory should be polished with Fibro+.
- Scientific studies have shown that horizontal microgrooves particularly support fibroblast attachment therefore Fibro+ should be used in a circular motion during polishing.

TRIM – Tissue Related Implant Management

For all implant diameters per system - one abutment line

Only one abutment diameter for each SKY implant system means fewer prosthetic components:

**mini²
SKY**

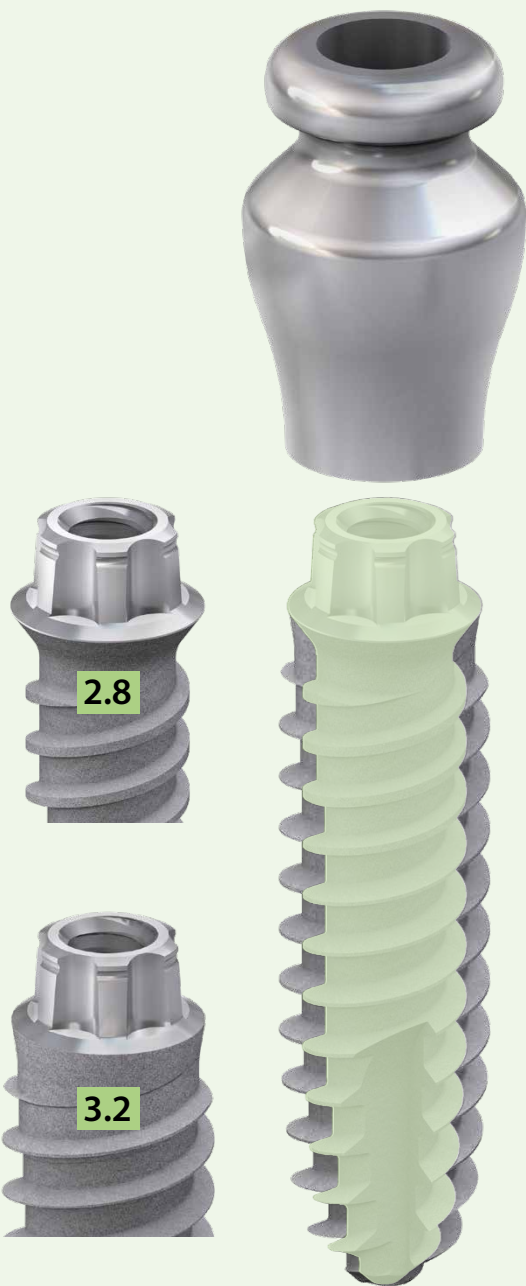

blue SKY **narrow SKY** **classic SKY**

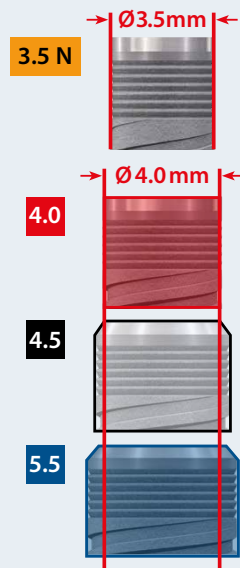
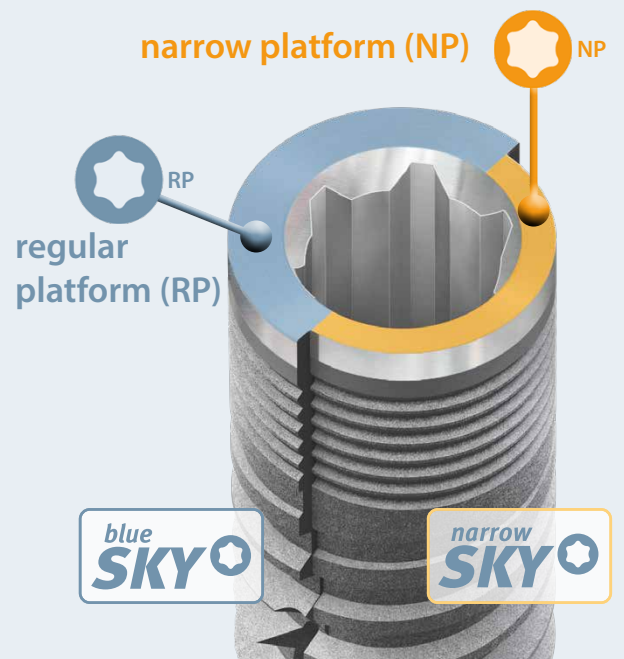

The platform switch develops with increasing diameter

- simple ordering and efficient storage
- safe to use
- no risk of confusion

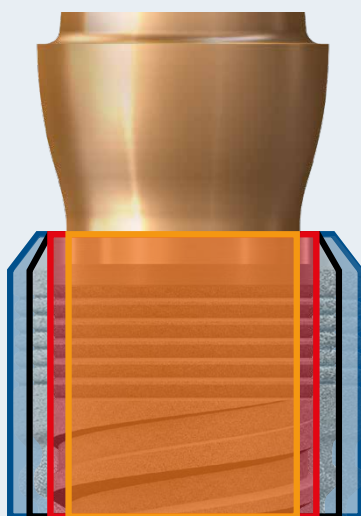

3.5 N 4.0 4.5 5.5

copa SKY

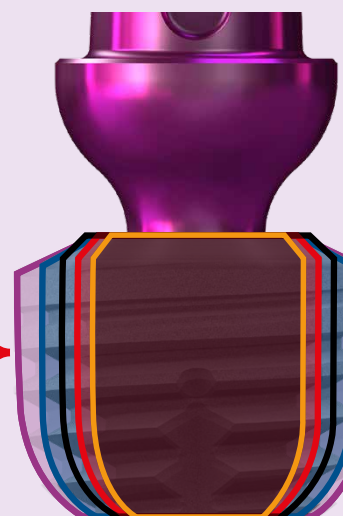
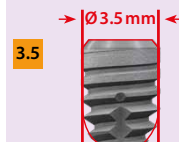

3.5 4.0 4.5 5.0 6.0

TRIM – Tissue Related Implant Management

16

Implant abutment connections



High conical very stable external connection for slim and diameter reduced implants.

- 5° cone
- 1.5 mm height



Millions of proven Torx connections

- 3.5 mm tube in tube
- Easy, safe placement of abutments
- Six abutment positions

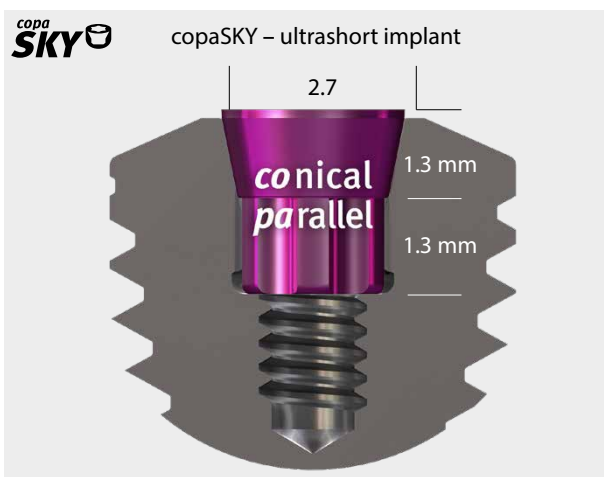

Conical and parallel-walled stable connection, which also enables very short implants.

- 23° cone - 1.3 mm long - Parallel Torx - 1.3 mm long
- No Morse taper effect - abutments easily removable
- Screw retained constructions possible

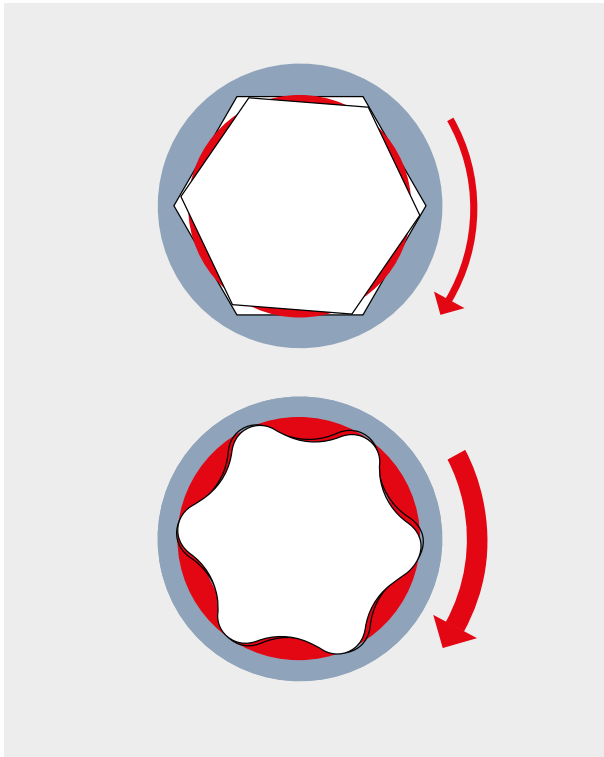

For implants with a hexagonal connection, the force is transferred from a relatively small surface when the implants are inserted therefore, high torques often result in the insertion tool getting stuck in the implant.

Torx®: has six large force transfer surfaces

- significantly higher torques for the same force applied
- easier insertion of the implant
- no damage to the internal geometry at a high torque either
- The insertion tool with Torx jams far less frequently in the implant than an insertion tool with hexagon

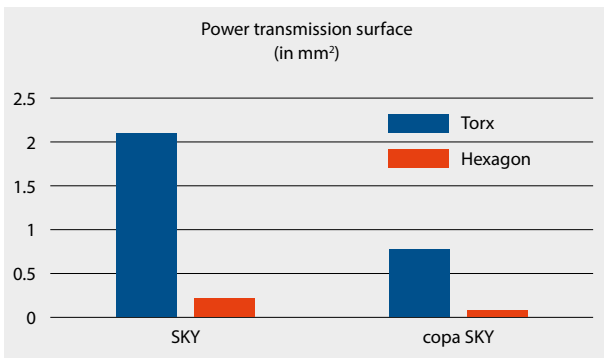

The area of SKY and copaSKY connections that are available for power transmission compared to the area that would theoretically be available for a hexagon.

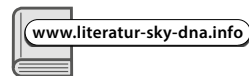

TRIM – Tissue Related Implant Management

SKY implant design for maximum primary stability

Immediate restoration places particular requirements on an implant system. The design of the SKY Implants and the corresponding surgical protocol ensure high primary stability in all bone qualities and therefore form a reliable basis for immediate restoration.

Conical cylindrical implant shape

Optimal and uniform load distribution of the chewing forces

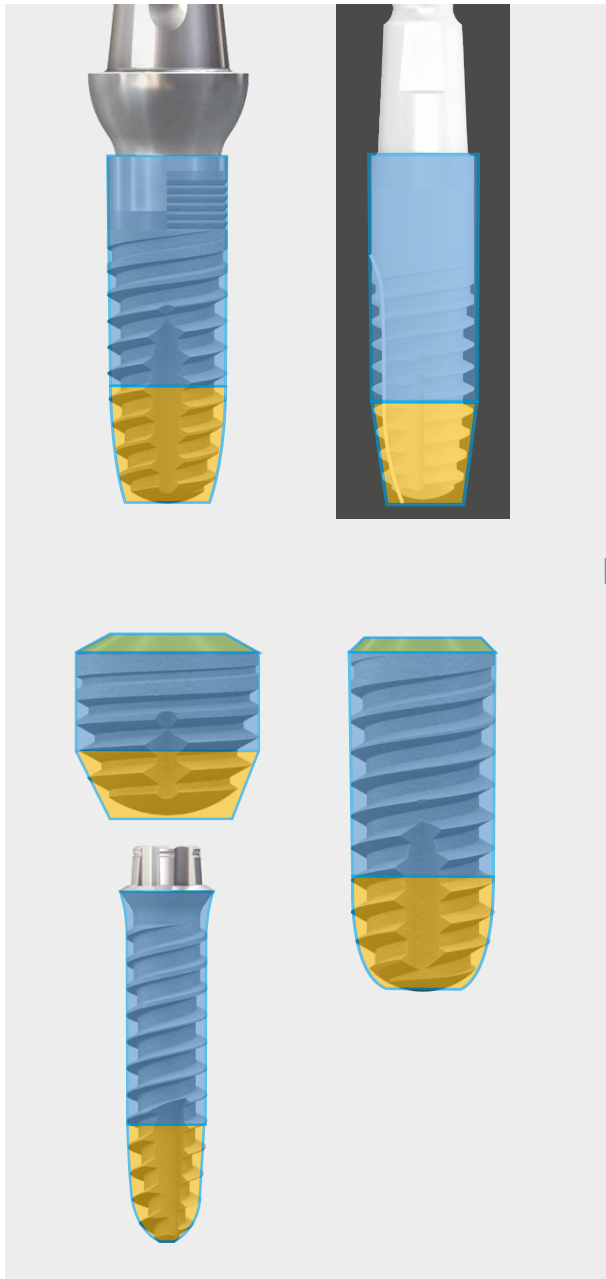

Bone friendly thread

Gentle and smooth insertion in just a few rotations

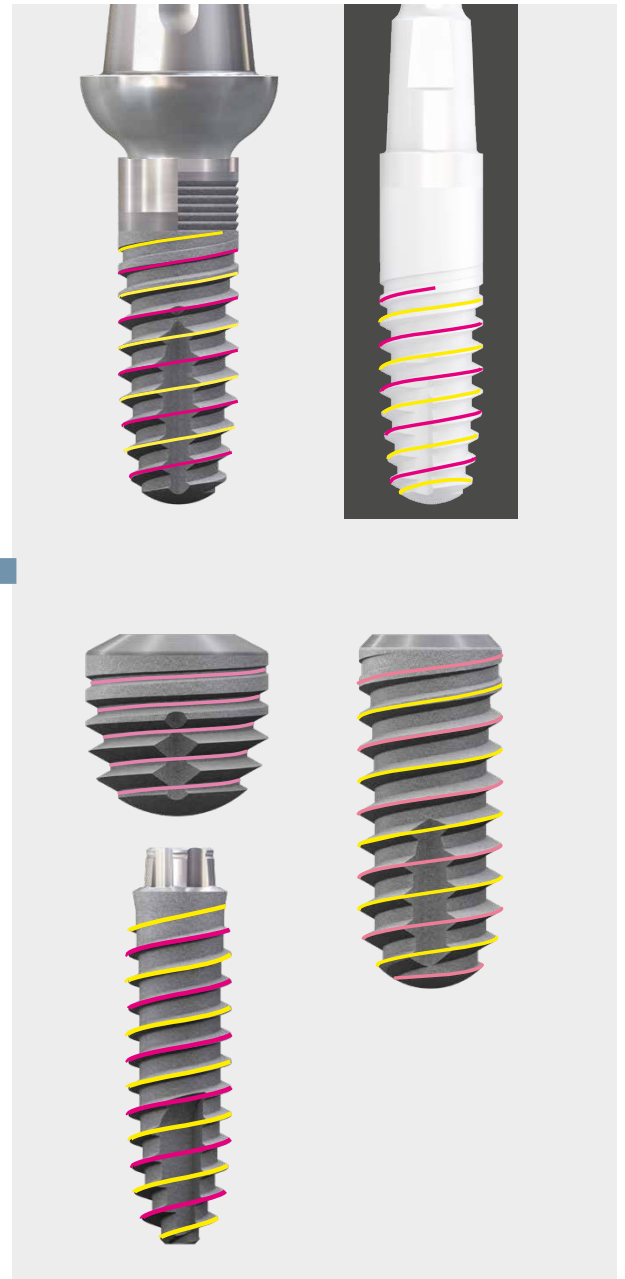

Back taper: no friction with cortical bone

Cylinder ensures high friction in the soft bone

Cone facilitates and accelerates insertion with high primary stability

Self-cutting compression thread

- Bone-preserving

Surgical protocol tailored to bone quality

Primary stability in every quality of bone

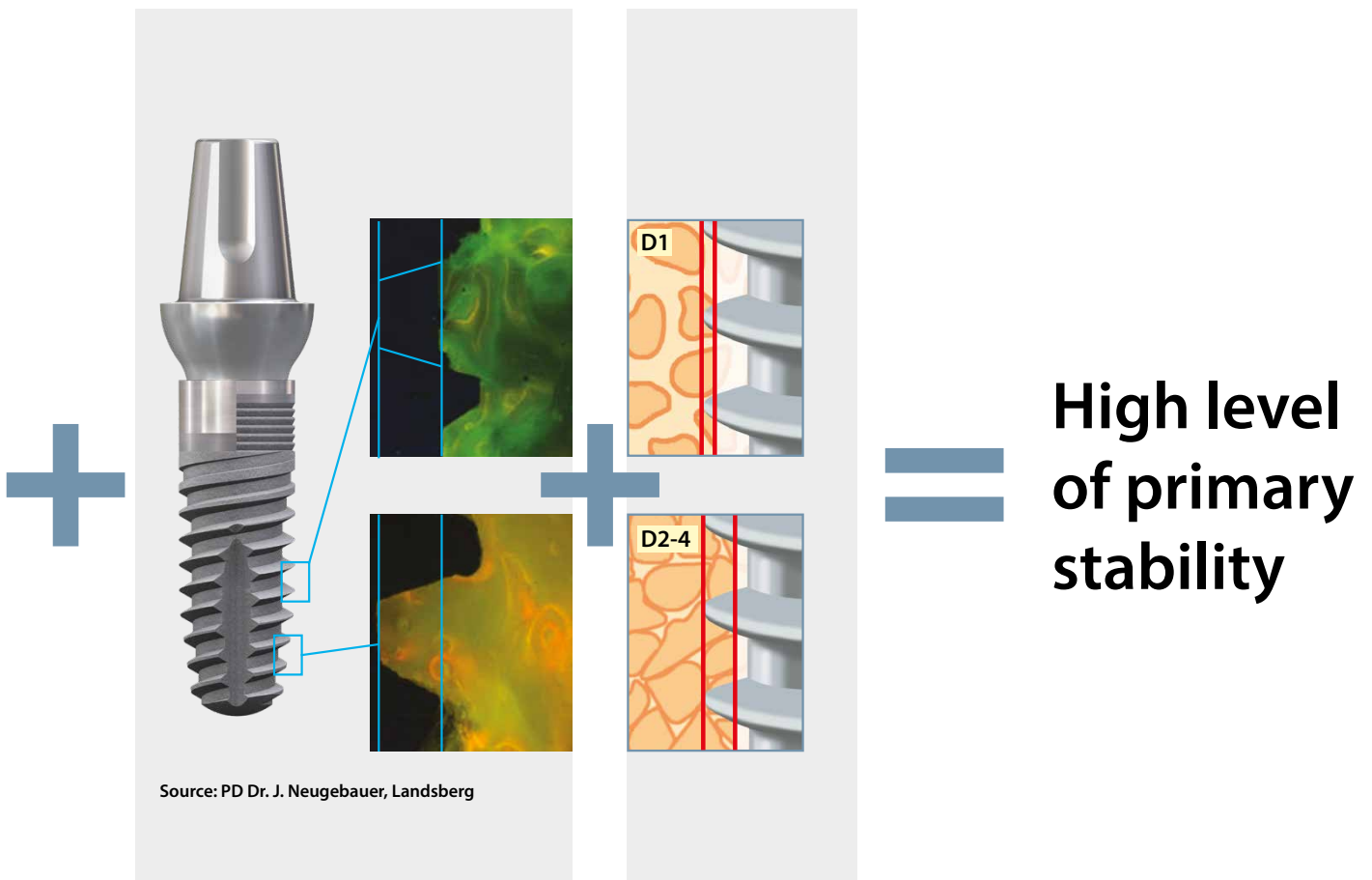

With SKY implants from bredent and the corresponding surgical protocols, primary stability of more than 30 Ncm or 65 ISQ is achieved in more than 90% of cases.

TRIM – Tissue Related Implant Management

Best pure titanium

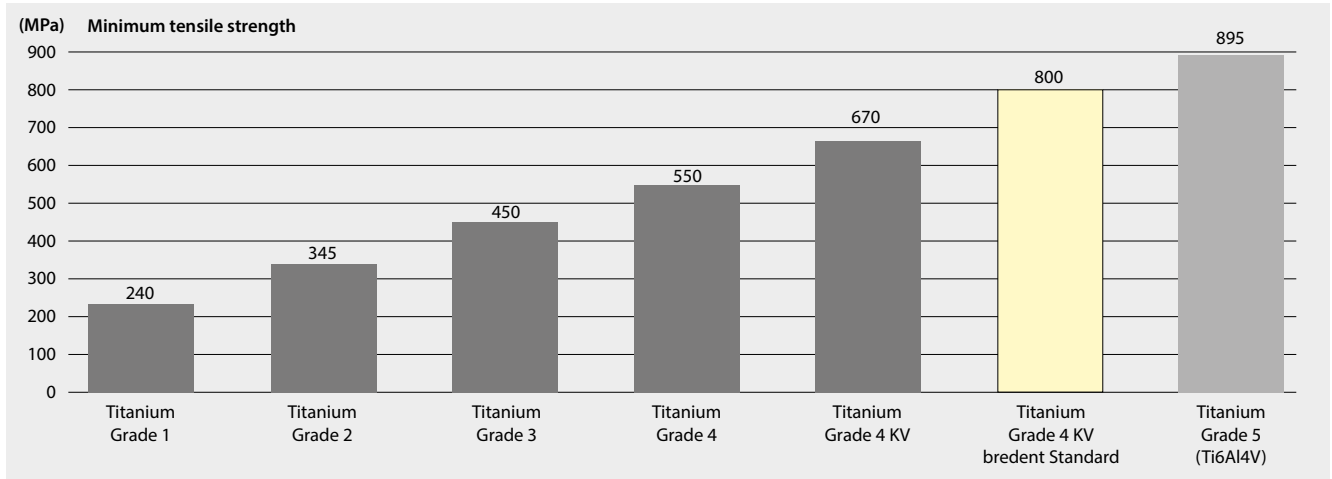

Element	Titanium grade 4 KV	Grade 5 titanium Ti6Al4V alloy	
	% max.	% min.	% max.
N	0.05	–	0.05
C	0.08	–	0.10
H	0.0125	–	0.01
Fe	0.50	–	0.40
O	0.40	–	0.20
Al	–	5.50	6.75
V	–	3.50	4.50
Ti	> 98.9 %	~ 91 %	> 86.99 %

For all implants and abutments only pure grade 4 KV titanium is used.

KV stands for cold-formed, which describes the manufacturing process of titanium rods, in which the rods are only pulled under pressure. This results in greater stability. We only select titanium rods that achieve a minimum mechanical stability of at least 800 MPa. With this internal bredent standard, we almost reach the values of grade 5 titanium of an alloy containing up to 6.75% aluminium and 4.5% vanadium with pure titanium. The health risks of aluminium and vanadium as the cause of intolerance reactions or other illnesses have not been conclusively investigated.

Best zirconium

Structure of zirconia

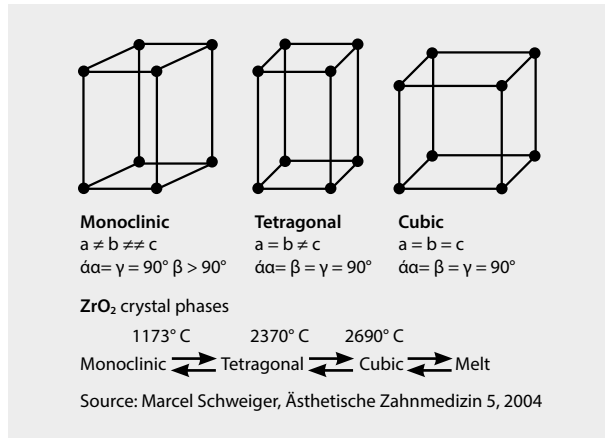

The zirconia dioxide used for whiteSKY implants has a tetragonal structure, which offers the best mechanical stability for oral implants (Fig. 1). This structure only occurs in nature at temperatures between 1173°C and 2370°C. Yttrium is added to stabilize the structure at room temperature.

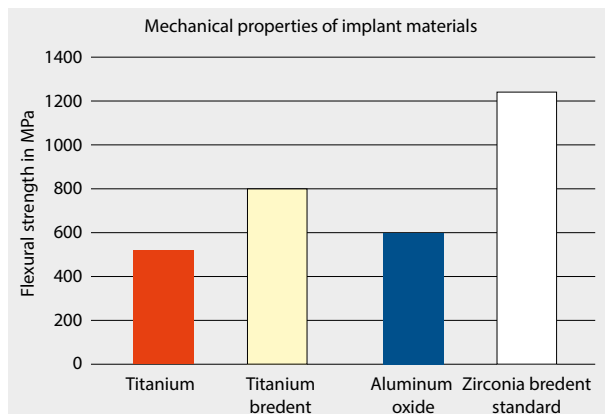

Maximum strength for brezirkon

Three times as strong as titanium

In its unground condition, the strength of zirconia is triple that of titanium and double that of aluminium oxide (Fig. 2). Industrial grinding increases its strength even further, meaning that a strength of approx. 2,000 N can be achieved in implants.

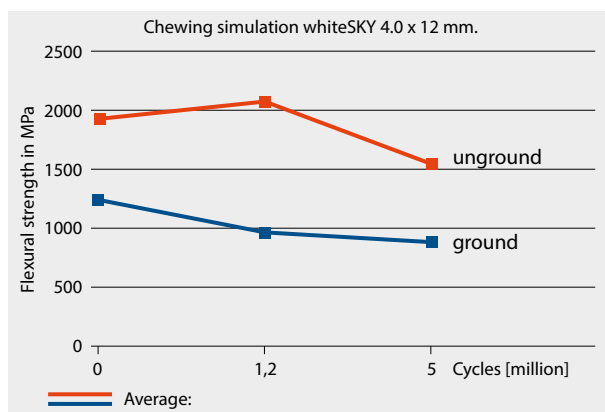

Studies on the chewing simulation University of Freiburg, Prof. Kohal. Presented at DGZPW Conference Wuppertal 2008

In a study, Prof. Kohal from the University Freiburg found that zirconia loses about 30% of its strength, after 2 million cycles in the chewing simulator which corresponds to about 10 years in the mouth. Therefore it is necessary for the long-term success to provide zirconia implants with sufficiently high initial stability to enable 20 and more years of safe use of the patient. Even customized whiteSKY implants had always a more than sufficient stability available. To date no broken whiteSKY implants are documented.

Physiological prosthetics - conventional

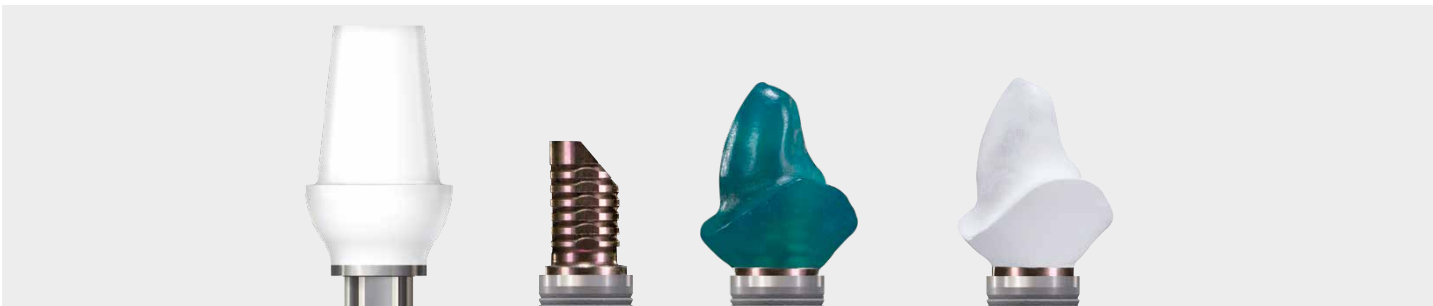

Prosthetic components with physiological material properties support safe and predictable immediate restoration. The elasticity in the bone area protects it from overload during the osseointegration phase. Physiological elasticity also protects in the long term against incorrect loads, such as parafunctions, e.g. bruxism, which often only occur years after the restoration. In addition, our physiological materials have a major advantage that they can be easily repaired even after years, unlike ceramics.



Physiological prosthetics – digital



Image: ZTM Antonio Lazetera, Savona, Italy



Image: Lab. Od. Antonio Lazetera, Savona, Italy

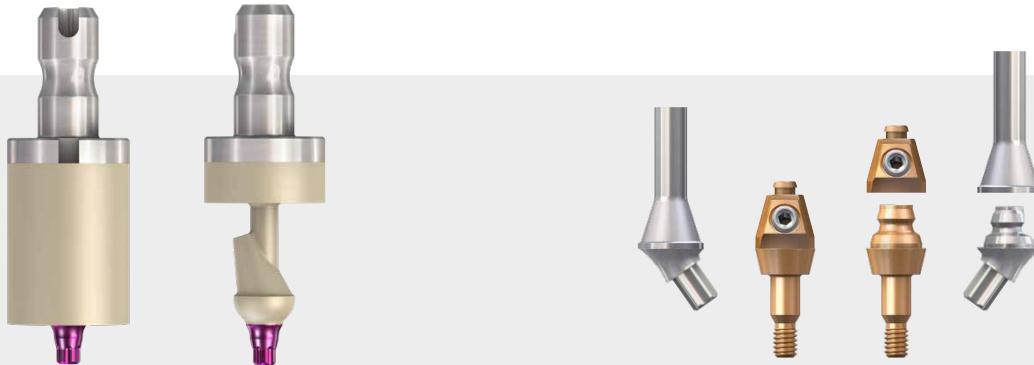

TRIM – Tissue Related Implant Management

24

visio.lign system - Permanently perfect aesthetics



crea.lign

create natural beauty

veneering composite

The light-curing composite features impressive natural

opalescence and unparalleled light transmission for natural beauty.



novo.lign

veneer natural beauty

veneers

The novo.lign veneers feature an extended neck and a natural depth thanks to the morphological layer structure. The gold standard in implant prosthetics.



neo.lign

choose natural beauty

denture teeth

The neo.lign denture teeth feature the same shades, designs and materials as the novo.lign veneers – optimised for fixed/removable restorations.



visio.CAM

design natural beauty

composite blanks

The material benefits from the visio.lign system are also available for CAD/CAM processing. The blanks from the visio.CAM line are compatible with the entire visio.lign system.



visio.paint

colour natural beauty

stains

The visio.paint stains enable fast and simple individualisation of veneers.



bond.lign

secure natural beauty

primer/bonder

The primer/bonder system for a permanent and secure chemical adhesive bond between all system components and common framework materials – including BioHPP (PEEK).



Crown abutments

With the visio.lign system, occlusally screwed crown abutments can be produced quickly and easily both conventionally and digitally. In this way, in many cases, it is possible to treat a patient in a few hours with an immediate and definite restoration.



SKY fast & fixed full arch immediate restoration and bridges

In definitive restoration, the visio.lign system shows its strengths. With a wide range of materials and colours, it allows dental technicians to achieve the desired aesthetic result conventionally and digitally. Unlike ceramics, they can see one to one what they are doing. With 2-in-1 technology, the BioHPP framework and the veneer from HIPC are milled on the basis of a data set.

crea.lign materials push the boundaries of dental technician creativity for aesthetic customisation



Fixed & removable

Unique and aesthetic hybrid prostheses made of BioHPP and visio.lign materials offer the patient a high level of comfort. Also as a long-lasting telescopic restoration.

TRIM – Tissue Related Implant Management

26

copaSKY - ultrashort implants

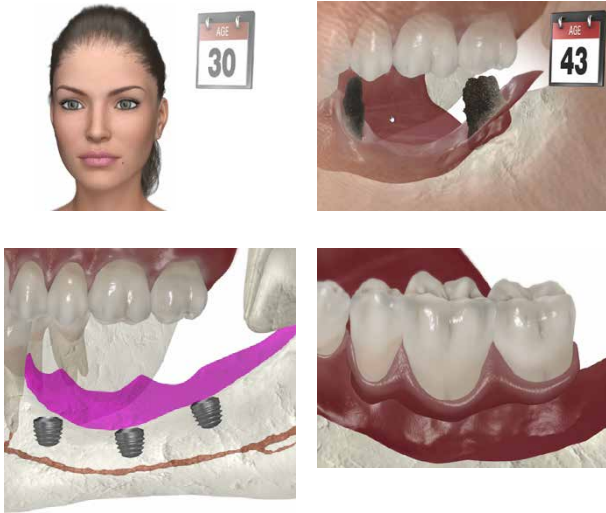

The average German is in their early 30s when they lose their first tooth, often in the posterior region. It is still predominantly treated with a conventional bridge on 2 adjacent teeth.

Under the conventional bridge the bone is resorbing and secondary caries is destroying the teeth in more than 50% of the cases in 15 years.

The result is a highly atrophied posterior region, for which there are few therapeutic options:

Tooth-supported removable dentures, such as clasp borne prosthesis and telescopes damage the remaining teeth and are rejected by the patient.

Augmentations are complex and involve a high risk of failure.

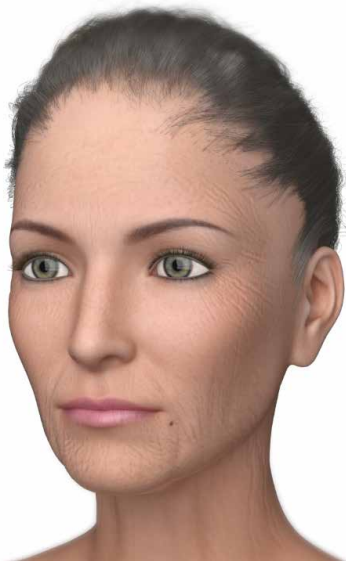

- Here the short copaSKY implants offer new therapy options
- Of course the limits of the ultrashort implants must be observed:
- Tooth-for-tooth restorations in the posterior region
- Bridges with a maximum of one pontic in the front connect copaSKY ultrashort and long implants for bridges if possible
- No extensions for bridges and single teeth
- Physiological prosthetics made of BioHPP and visio.lign protects the ultrashort implants against overload

Avoiding extensions

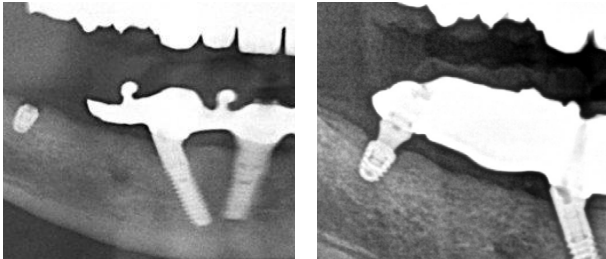

A meta-analysis by the University of Heidelberg found that the complication rate for implant-supported products with extension ranges from 7% to 12%. The evaluation of bredent medical complaint statistics shows a similar picture. Extensions and extra-axial loads are the cause of more than 90% of screw loosening and fractures of screw and abutment.

Klotz, et al.; Quintessenz 2017; 68(11):1233-1250

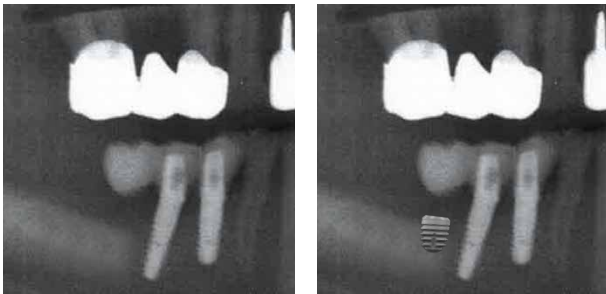

Here is a representation of how the use of ultrashort copaSKY implants could create a stable and durable restoration. The cases shown originate from our complaint statistics.

Avoiding augmentations

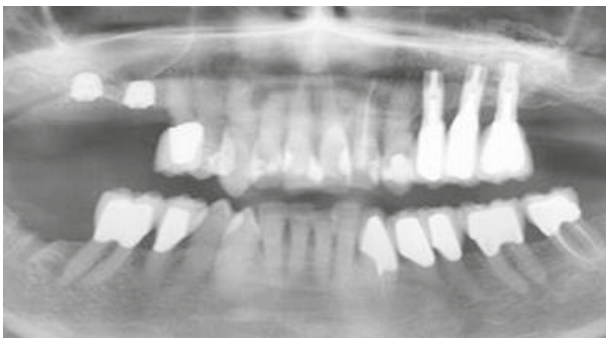

- Augmentation can be avoided with ultrashort copaSKY implants. Following scientific literature, augmentations are sometimes associated with high failure rates:
 - For vertical augmentations, failure from 10% to 100% is mentioned, depending on the technique used
 - External sinus-floor elevation reports perforations ranging from 20% to 30% and also high failure rates.
- The use of ultrashort copaSKY implants avoids augmentations and therefore the treatment time and cost is reduced.

TRIM – Tissue Related Implant Management

28

whiteSKY zirconia implants

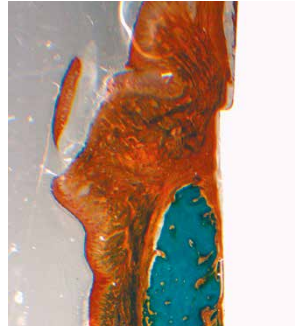
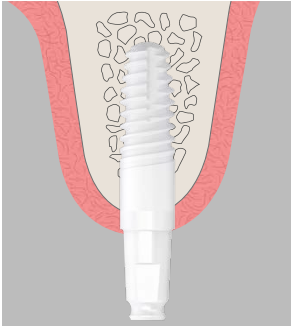

- Clinically proven since 2006
- Scientifically proven
 - High success rate - over 95% after 10 years
 - Excellent Pink Esthetic Score
 - Stable bone conditions around the implant
- Immediate restoration
- High stability - no fractures
- whiteSKY is the only zirconia implant with published 10-year results.

whiteSKY – 2nd Generation – coming soon

Proven and further developments

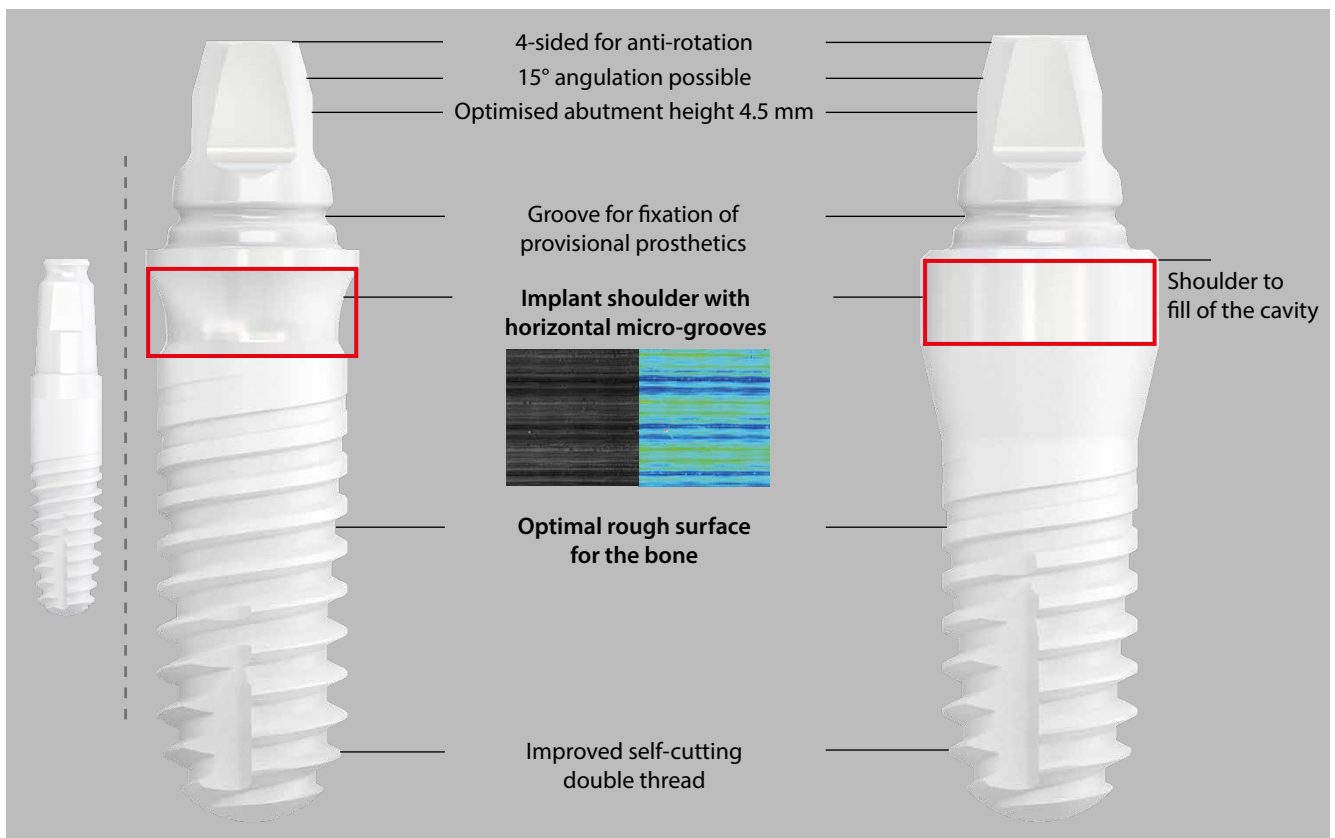

Maintaining what is proven and developing it further is the idea of the second generation of whiteSKY. Same highly stable material in the same processing process with improvements with two forms of neck design. The improvements in the superstructure design facilitate prosthetic restoration both temporarily and definitively and are optimised for the digital workflow.

whiteSKY – 2nd Generation – coming soon

How can you optimally care for your clinical case? With the second generation of whiteSKY, we give you the choice. Space for soft tissues or filling the extraction alveolus. You have the same prosthetic options, either conventional or digital.

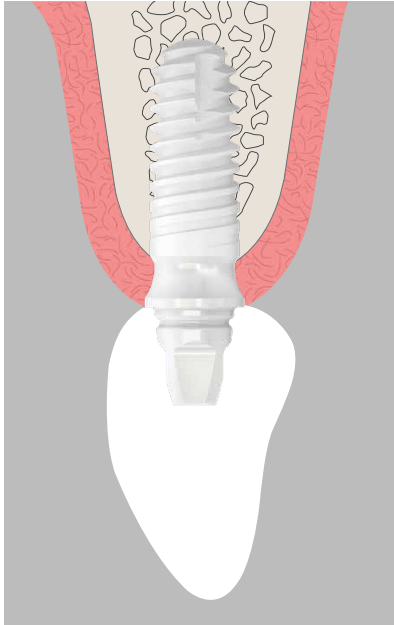

whiteSKY TISSUE LINE

- Gives the soft tissue space for attachment
- Gives the soft tissue space for attachment
- The cavity is optimally filled with Tixxu
- No customisation necessary
- For example, for socket shield technology (PET or socket shield technique)

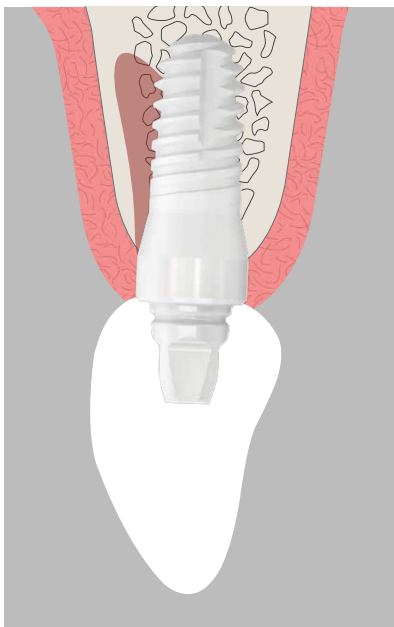

whiteSKY ALVEO LINE

- For filling the cavity directly after extraction
- Implant can be customised

Two-piece zirconia implants:

Our mission is to provide patients with long-term, safe treatment. All previous tests or systems on the market do not meet our requirements:

- Metal screws contradict the metal-free concept and cannot produce cold welding in the zirconia, which poses a very high risk of screw loosening.
- Plastic or carbon screws have a very large screw head, which makes the abutment walls very thin, which can result in fractures in the long term when zirconia ages.
- Cementation in the sulcus region is associated with a high risk of contamination.

TRIM – Tissue Related Implant Management

Solutions for narrow bones

miniSKY - the solution for narrow atrophied jaws

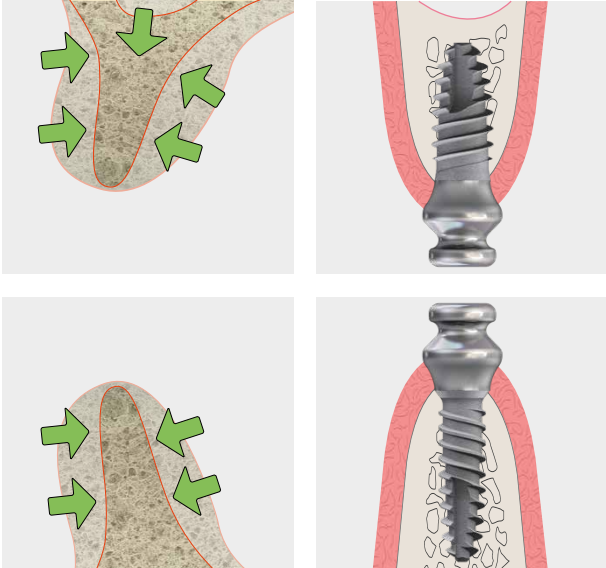

Bone loss is often significant, particularly in older people with a tissue borne prosthesis. miniSKY implants cope with thin and narrow bone situations and offer the patient a functional, stable and economic prosthesis

miniSKY - extremely stable external connection thanks to Form fit

Competing implant abutment connection

mini²SKY implant abutment connection

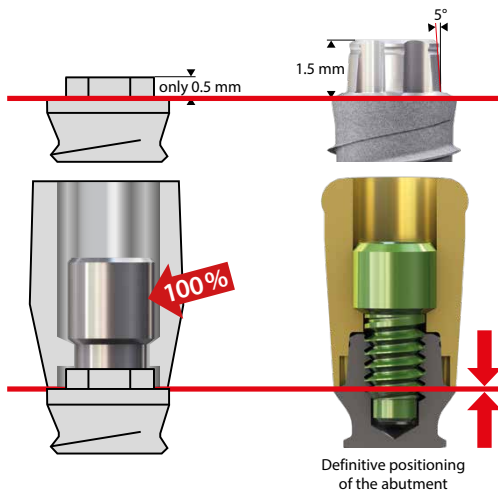

The properties of the mini²SKY connection offer long-term stability and safety. Compared to the competition the very high external connection with 5° cone offers the prosthetics a firm fit and optimal power transmission. The chewing forces are transferred directly into the implant via the abutment and therefore prevent overstraining of screws – Form fit.

miniSKY - rotation-proof prosthesis fixation

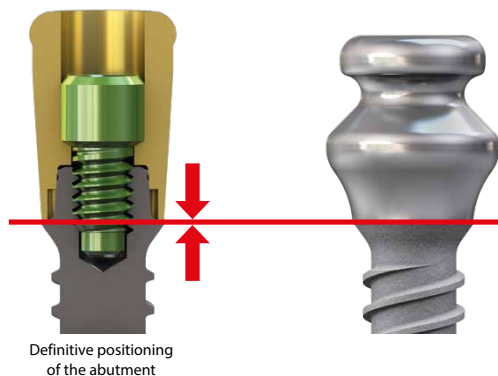

The attachments for fixation of prostheses are secured against rotation. This greatly reduces loosening and mechanical complications compared to, for example, a standard Locator®.

miniSKY - open healing only one surgical procedure

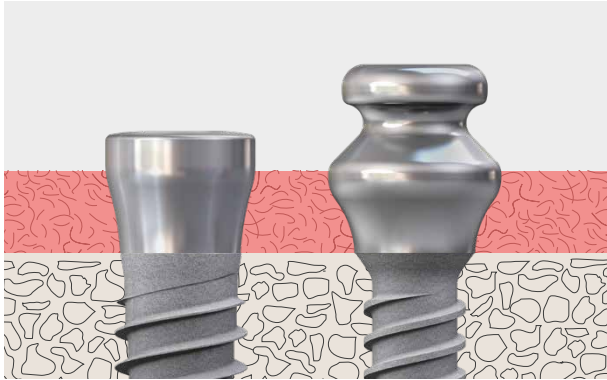

Reduction of treatment time and costs – miniSKY implants can be inserted transgingivally, which further shortens the treatment time. The abutments for prosthesis fixation also serve as gingiva formers. In the bone area, the proven osseo-connect surface is used on the implants. In the soft tissue area, the prosthetic components of a machined surface fit together for a perfect placement of the gingiva.

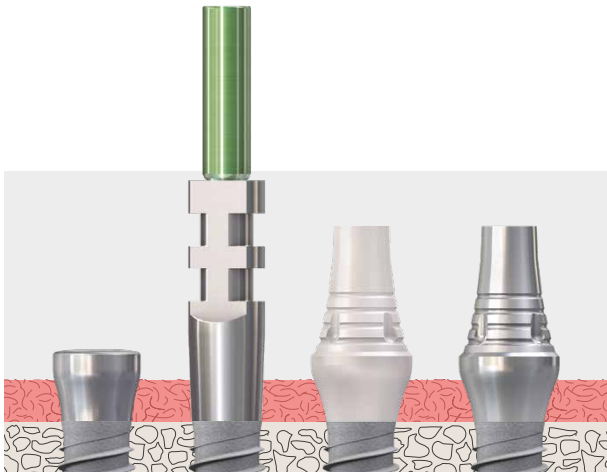

miniSKY - closes narrow gaps conventionally

Prosthetically variable - from the impression to temporary restoration to a high-end solution for the final prosthesis, the miniSKY system offers all the options of a fully fledged implant system.

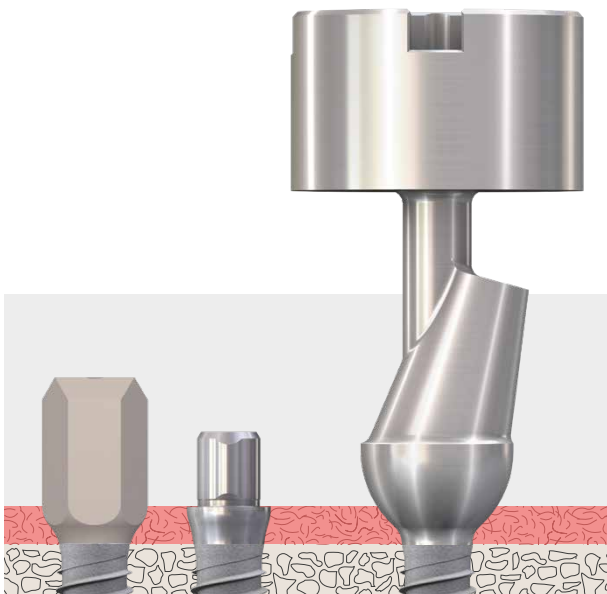

miniSKY -closes narrow gaps customised

miniSKY demonstrates its strengths not only for the fixation of prostheses, but especially for the treatment of narrow single tooth gaps - where standard diameter implants are simply too wide. In the digital workflow, customised restorations can be supplied quickly and costeffectively.

TRIM – Tissue Related Implant Management

Immediate restoration preserves bones and soft tissue

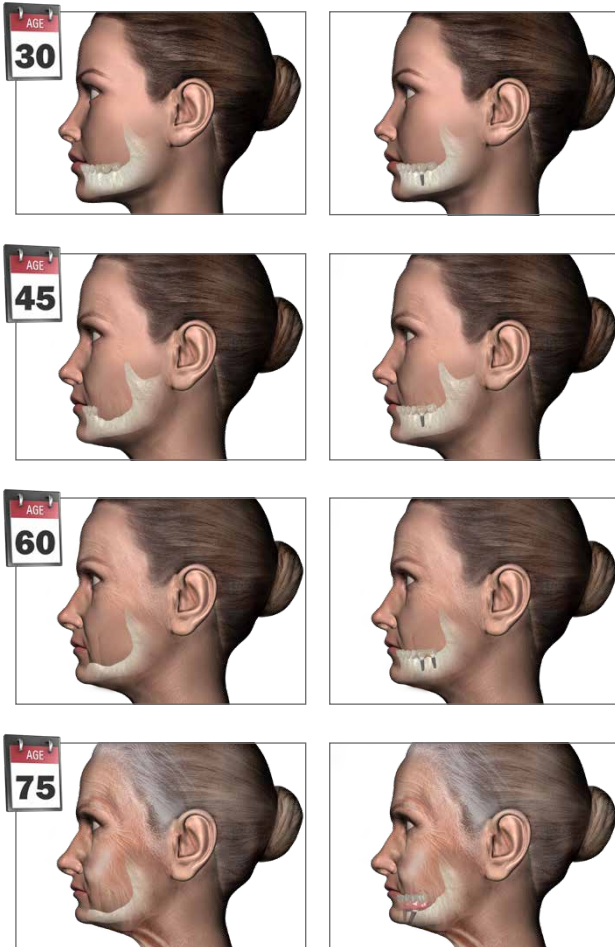

In order to preserve bone and soft tissue, a single tooth implant is the best solution in the event of tooth loss. However, most patients still decide against implant restoration:

- Because they are afraid of surgery
- Because it involves too many visits for treatment
- Because it is supposedly costly

The best thing from this patient group's point of view is immediate implantation with immediate restoration, as far as clinically possible. The gap can be closed with just a few visits for treatment and short treatment times.

No loss of stability during osseointegration

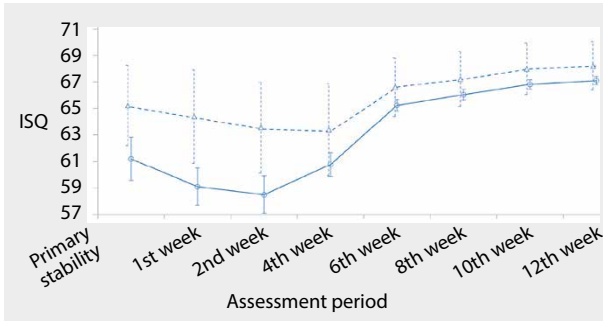

Changes to implant stability during the 12-week monitoring period.

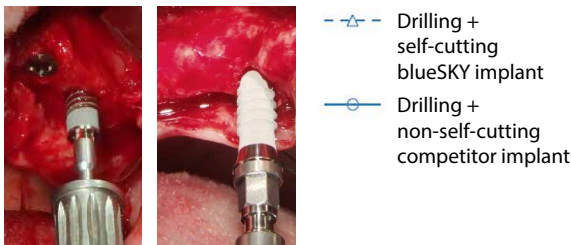

--△-- Drilling + self-cutting blueSKY implant
--○-- Drilling + non-self-cutting competitor implant

Source: Marković et al: Evaluation of primary stability of self-tapping and non-self-tapping dental implants. A 12-week clinical study, *Clinical Implant Dentistry and Related Research* 2013

Scientifically proven

A study by Prof. Marković, University of Belgrade, shows that the blueSKY implant is superior in comparison to competition implants having very high primary stability. It also shows that rapid osseointegration takes place with modern implant surfaces and that no loss of stability occurs after a few weeks. Secure immediate restoration is therefore possible.

Important:

The surgical protocol for the SKY system enables the primary stability of the SKY implants to be increased easily using condensation.

50% better osseointegration with immediate restoration

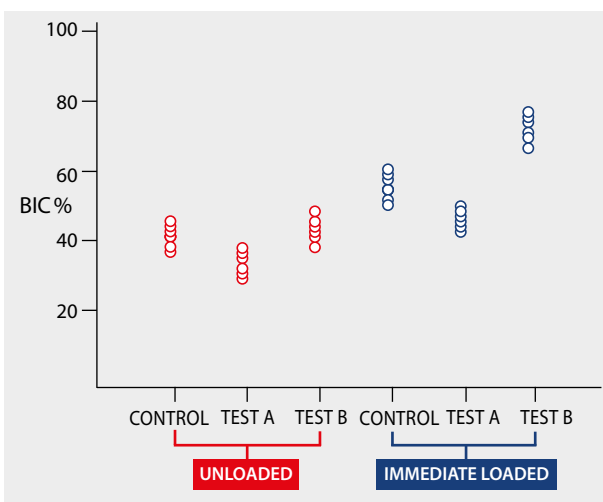

Control group: blueSKY
Test-groups: whiteSKY with different surfaces
 Test A - Sandblasted only
 Test B - Laser treated
Observation period: 3 months
Model: Animal studies in dogs
BIC = BONE IMPLANT CONTACT

This scientific study shows that immediate restoration improves osseointegration by at least 50%. This is the result regardless of the implant material and the surface treatment of the material.

Immediate restoration trains the bone and therefore stimulates growth of the bone cells. This study shows that the results of orthopedics can be transferred to oral implantology. Immediate restoration assumes the role of physiotherapy in oral implantology.

However, this also means that the bones must be protected from overload by appropriate treatment concepts and materials.

If there is sufficient primary stability, the implant should be treated immediately to improve the healing success.

Source: *Clio Implant Dent Relat Res*; 2014 Dec; 16(6):856-72. doc 10.1111/clid.12069.

Epub 2013 Apr. 5.

Histologic and histomorphometric behavior of microgrooved zirconia dental implants with immediate loading.

Delgado-Ruiz RA¹, Calvo-Guirado JL, Abboud M, Ramirez-Fernandez MP, Maté-Sánchez de Val, JE, Negri B, Rothamel D.

TRIM – Tissue Related Implant Management

One Time therapy Less is more

One Time therapy or 2 x component changes or 1 x component change

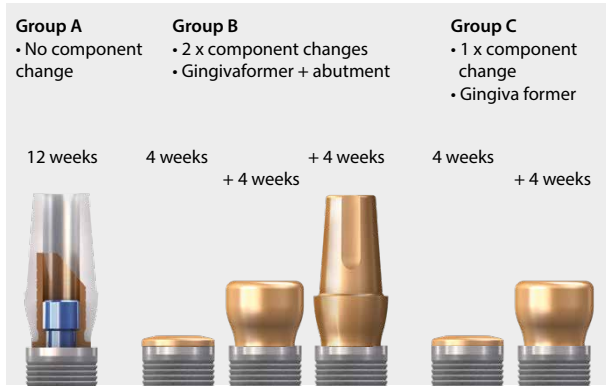

A recent study carried out by UCAM University shows that every component change in the prosthetic phase increases bone loss and deteriorates the quality of soft tissue:

- Group A: Immediate restoration with BioHPP SKY elegance – No component change
- Group B:
 - Healing with cover screw (4 weeks)
 - Gingiva former (4 weeks)
 - Abutment (4 weeks)
 - 2 x component changes
- Group C:
 - Healing with cover screw (8 weeks)
 - Gingiva former (4 weeks)
 - 1 x component change

one-time Therapy versus reconnection

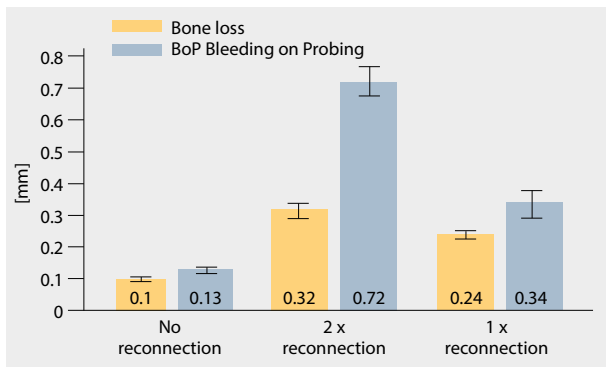

One Time therapy significantly less bone loss:

- Approx. 3 times bone loss with 2 component changes
- Approx. 2 times bone loss with 1 component change

One Time therapy significantly less BoP

- Approx. 5-6 times the BoP for 2 component changes
- Approx. 3 times the BoP with 1 component change

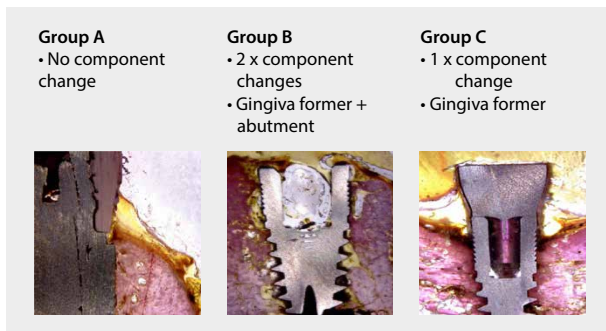

Summary:

Fewer interventions result in stable bones and healthy soft tissue.

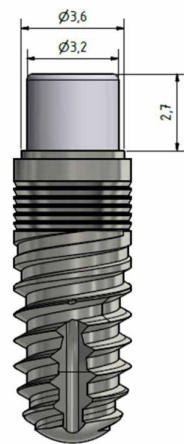
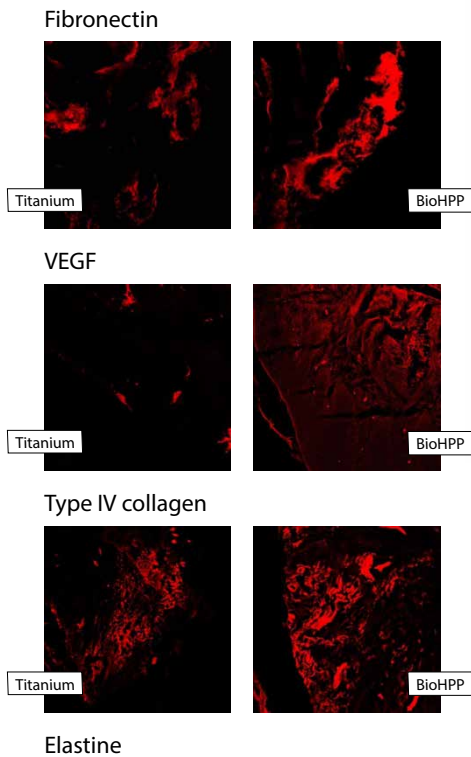

Axial and coronal view of experimental abutments

A human study carried out by the University of Messina shows that different soft tissue cells are deposited on both titanium and BioHPP gingiva formers:

Result:

- BioHPP generally has more soft tissue cells than titanium.
- The best results of soft tissue placement are achieved if a change of prosthetic components is avoided.

One Time therapy for all indications

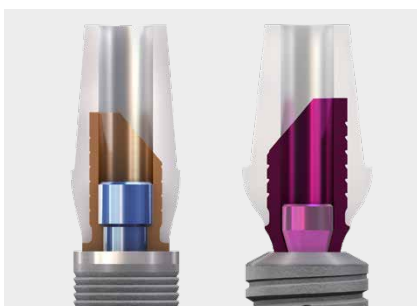

BioHPP SKY elegance abutments are ideal for immediate restoration without component change

- As a definitive crown abutment in the analogue or digital workflow - no cementation in the patient's mouth necessary
- As a definitive abutment with cemented crowns in the analogue or digital



State of the art screw-retained bridge restoration

- Digital or analogue impression at abutment level
- Immediate temporary restoration
- No abutment replacement between temporary and definitive restoration

TRIM – Tissue Related Implant Management

Immediate restoration - success for surgery

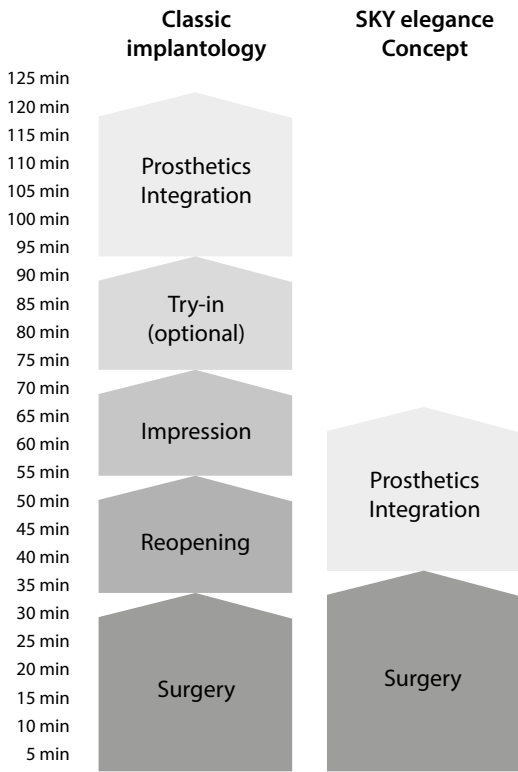

Compared to traditional implantology, the treatment time is reduced by about half for immediate restoration. Even more importantly, however, is the reduction in visits to dentists, which involve effort and stress for each patient. Immediate restoration provides them with at least satisfactory solutions to their problem on the first day of treatment and in many cases, even their definitive restoration.

This type of treatment makes it easier for the patient to choose implant restoration.

In addition to reducing the treatment time, dental practice also has other advantages, such as less time required to prepare and clean a treatment room.

Immediate restoration is a benefit for both the dental practice and the patient.

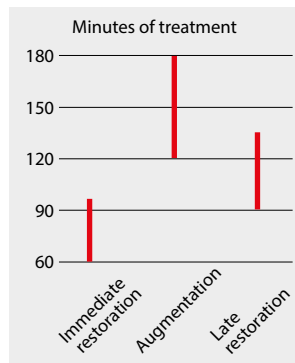
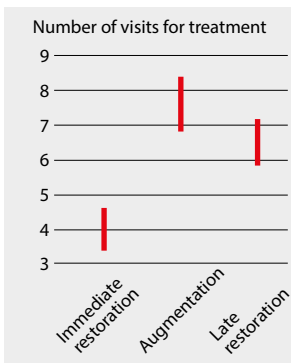

Every visit for treatment involves a great deal of effort for most patients and can result in a loss of salary. In addition, few patients like to go to the dentist. Therefore, many patients are willing to pay a higher amount per minute of treatment for fast care rather than standard care.

Much fewer components in the event of immediate restoration

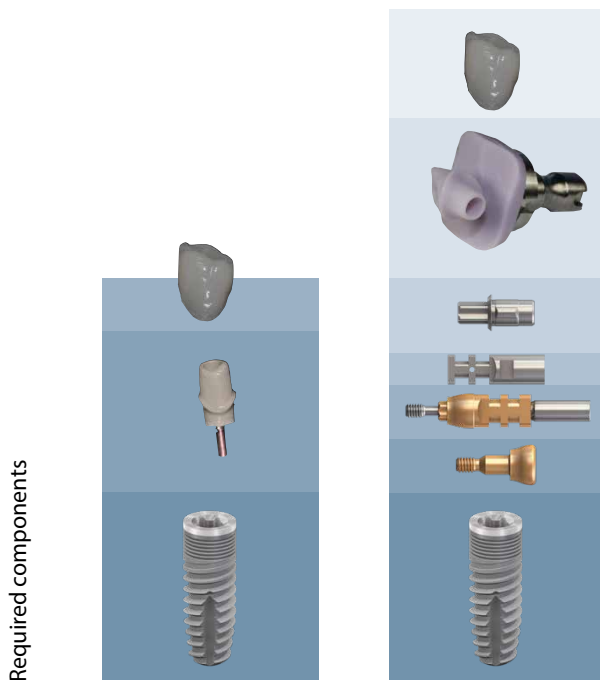

The One Time therapy with SKY elegance leads to significant savings in material and treatment time compared to conventional workflows. As a result, the entire implant therapy can be offered at a more favourable price without the dentist's fee being reduced.

Immediate restoration, when?

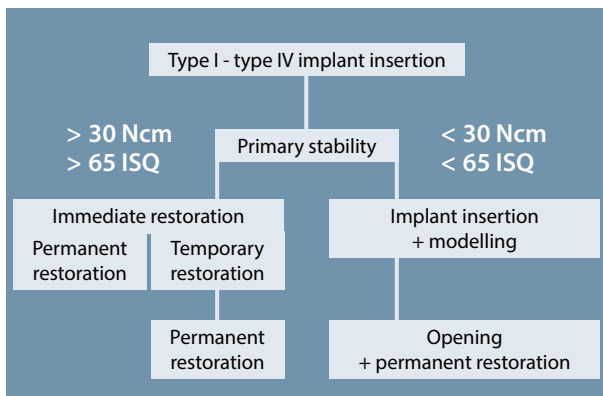

The decisive criterion as to whether immediate restoration is possible is the primary stability of the implants placed. If the primary stability is over 30 Ncm (65 ISQ), immediate restoration should be carried out, as this stimulates the bone and promotes healing.

If the primary stability is under 30 Ncm (65 ISQ), we recommend modelling the implant position during the operation and inserting the permanent restoration into the opening.

This way, the treatment time is significantly shortened¹⁾.

¹⁾ Literature:
Deutsche Zahnärztliche Zeitschrift [The German Dental Journal] 2014; 69 (6)
F. Beuer et al.: The Munich Implant Concept (MIC): a combination of intraoral scannin device and digital fabrication.

Unique prosthetic solutions

The best bredent solution for every indication

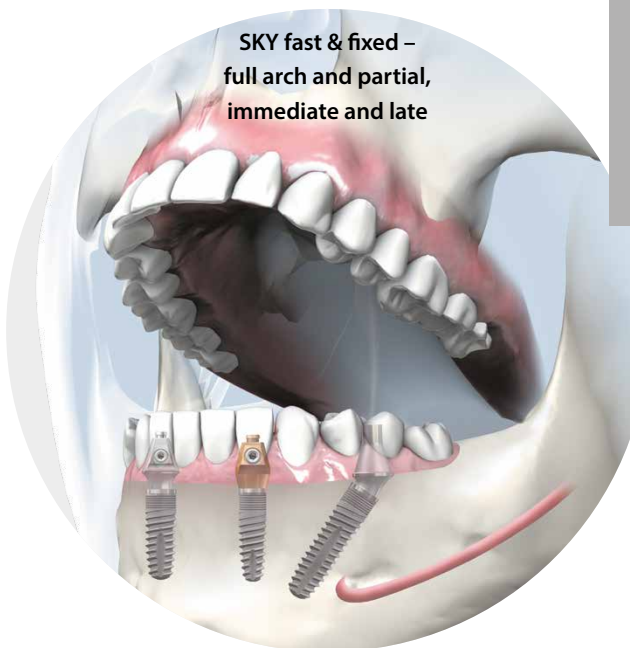

therapy	SKY narrowSKY classicSKY blueSKY
Single tooth	SKY elegance
Full arch screw retained bridges	SKY fast & fixed SKY uni.cone

cemented	exo
Fixed & removable	TiSi.snap retention.sil
	SKY elegance Telescopes

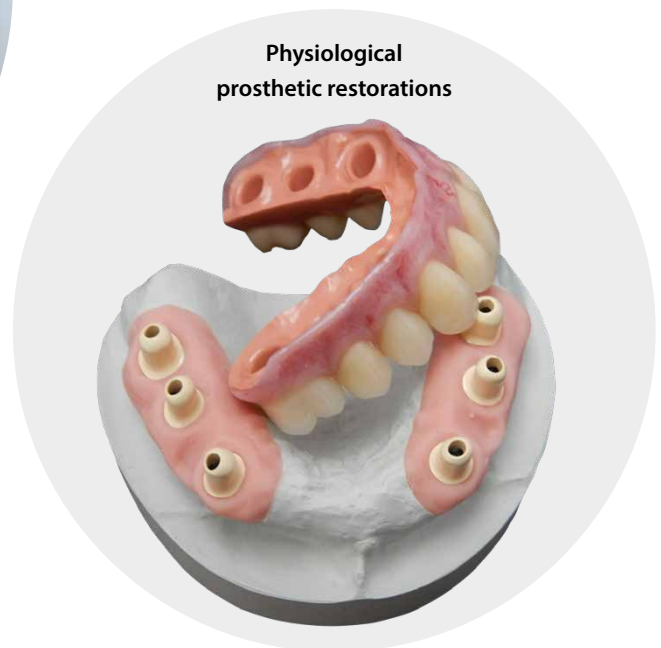

copaSKY exso - the multi-functional abutment system

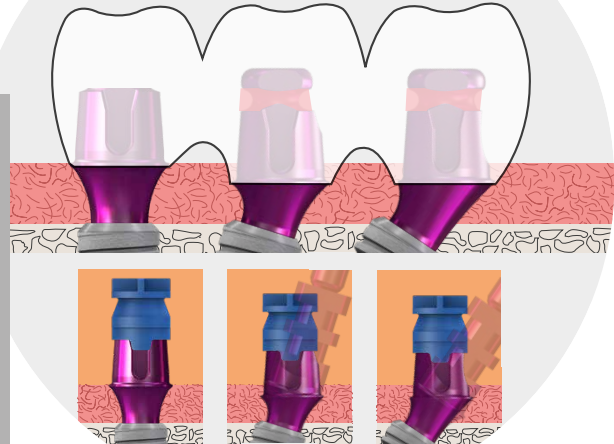

copaSKY	miniSKY
SKY elegance	---
SKY uni.cone	---
Bridge abutment	---
exso	---
TiSi.snap retention.sil	TiSi.snap retention.sil
SKY elegance Telescopes	---

Form fit bridge abutments

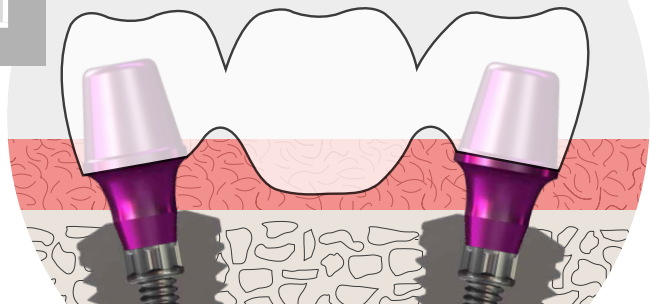

Natural chewing sensation due to resilient prosthesis fixation

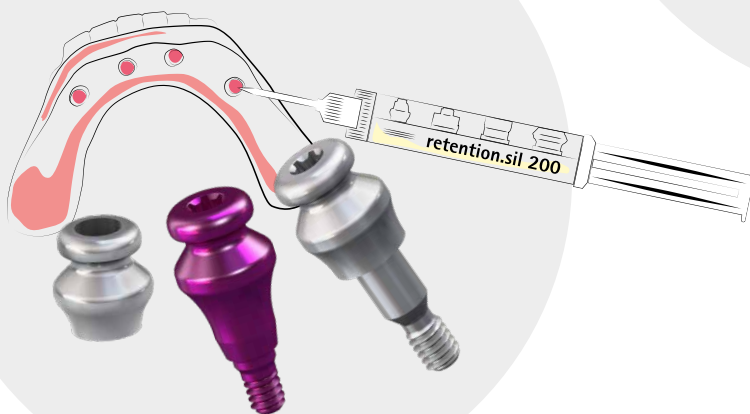

Unique prosthetic solutions

Implant - prosthetic solutions

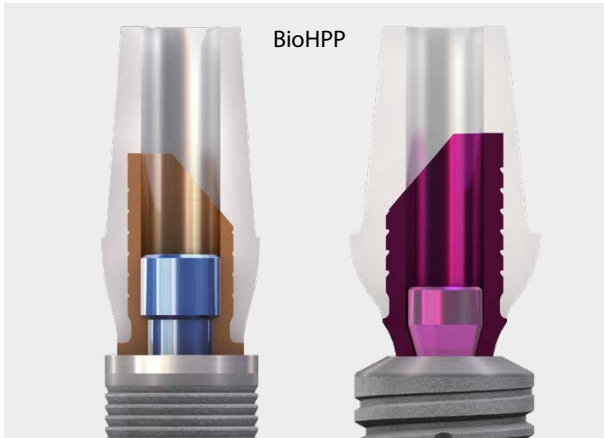

The ceramic reinforced High Performance Polymer BioHPP was specially developed for dentistry.

Compounding PEEK with ceramics produces a material with optimal properties for intra-oral use, physiologically biocompatible and durable. This material is injection molded onto the titanium base in a patented process resulting in gap-free monolithic hybrid abutment.

BioHPP SKY elegance cushions as a natural stress breaker load introduction to the implant. The abutment body of BioHPP has the same elasticity as bone so the maximum force introduction is reduced and the entire force is directed into the bone with a time delay.

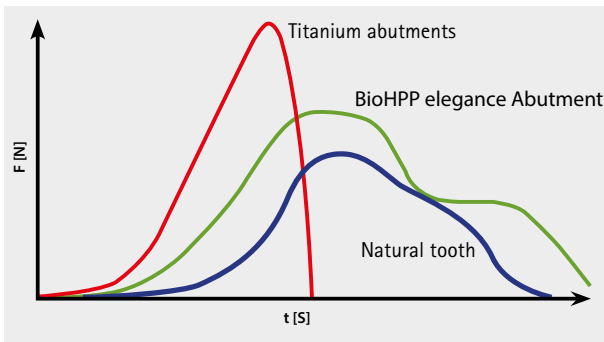

Optimal attachment of the soft tissue



Excellent soft tissue integration has been confirmed in both animal studies and clinical use.

Therefore, we recommend "One Time therapy". The abutment is placed immediately during the operation and not removed again, in order not to disturb the attached soft tissue.

The restoration can be performed as an occlusally screw retained crown abutment immediately and definitively or with temporary crowns, which are later replaced by definitive crowns.

Long-term stable bones and soft tissue conditions

5 year results BioHPP SKY elegance abutments

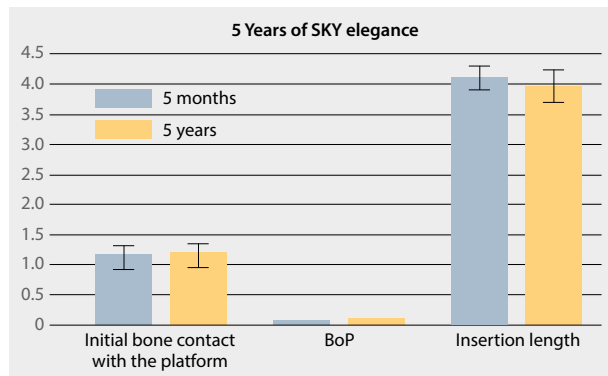
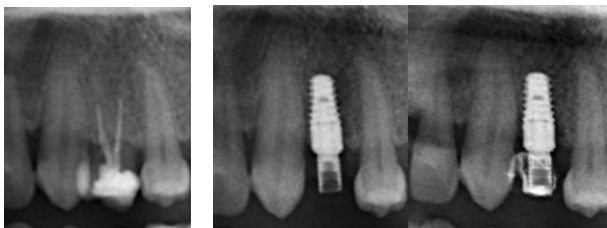

BioHPP SKY elegance abutments in immediate restoration provide stable bones and soft tissue conditions, as shown in a recent study presented at the EAO Congress 2019 in Lisbon.

- 40 blueSKY implants immediately restored with BioHPP SKY elegance in the digital workflow
- Observation period: up to 5 years

Results:

- Very stable bone conditions
- Very healthy soft tissue - practically no bleeding on probing (BoP)

Customised or pre-assembled - anything goes

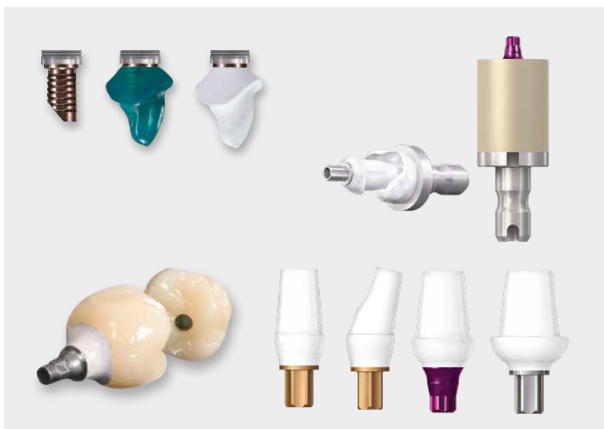

BioHPP SKY elegance abutments are available for SKY and copaSKY

- As stock abutments
- As customised abutments

The customised abutments can be manufactured in two ways:

- Conventional workflow by waxing and pressing in the bredent for2press device
- In the CAD/CAM workflow from BioHPP prefabs with open CAD/CAM systems. BioHPP prefabs are available in CAD libraries and many CAM libraries



Unique prosthetic solutions

SKY fast & fixed - Full arch immediate restoration

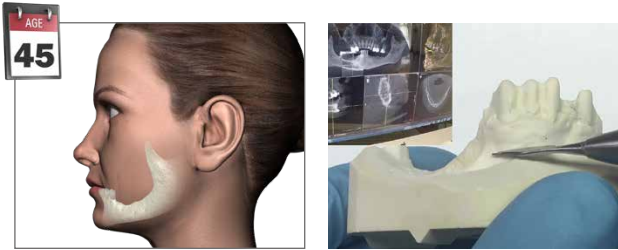

Patients losing their last teeth are aged from 45 to 70 years. They are a special customer group whose demands on the quality of life have significantly increased. They want a treatment that enables them to enjoy the decades of life ahead of them. In addition this patient group has a relatively high income and savings compared to other age groups. SKY fast & fixed is the ideal solution for this group of people.

In one clinical session the patient can expect:

- Extraction of teeth not worthy of preservation
- Implant insertion
- An immediate fixed bridge
- A fixed bridge immediately attached with a reduced number of implants
- The existing bone is optimally used and augmentation is avoided
- Only ONE surgical procedure

More than 100,000 patients worldwide have been treated. The 10-year results show stable periimplant hard and soft tissue results.

Literature:
Werbelow et. al. 2018

Comparison - conventional prosthesis

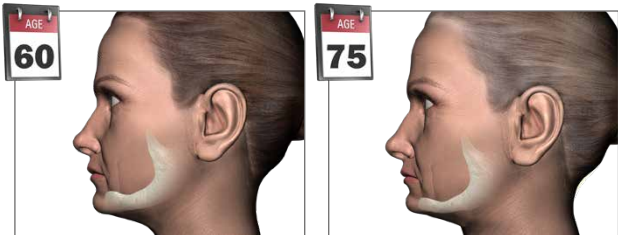

(copa)SKY uni.cone angulated

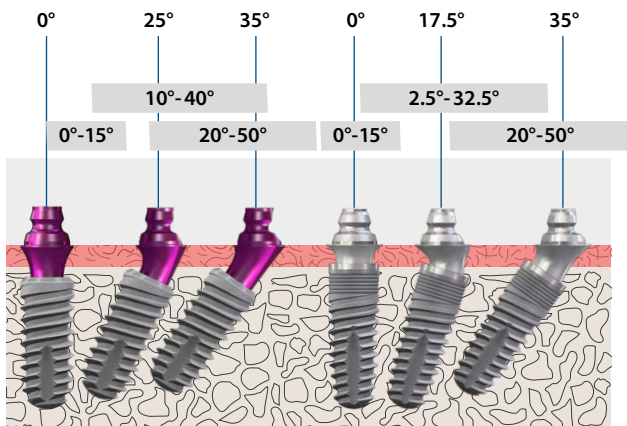

All angulations from 0° to 50° can be covered with the angulations of uni.cone abutments as well as the fast & fixed abutments.

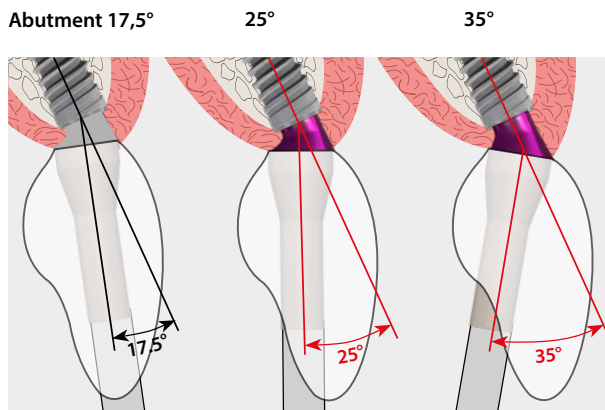

By using narrow, angulated abutments in the upper jaw labially instead the screw channel can be turned palatally so as to avoid aesthetic difficulties. This produces the same result as an angulated screw channel but with the same screws and screwdrivers.

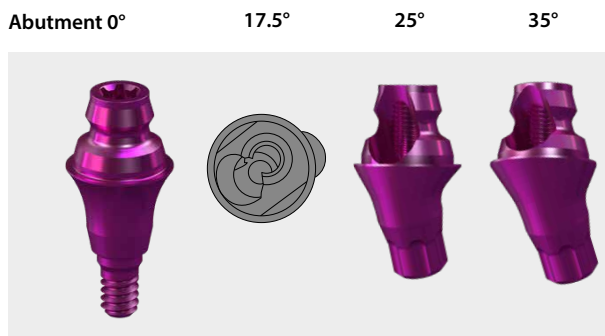

For all angulations, the occlusal thread of the abutments is always closed.

- No bending of the open thread
- Easy insertion of the screw
- Very stable connection therefore fewer screw loosening and fracture incidents.

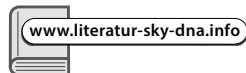

Unique prosthetic solutions

Bolted bridges - Unique solutions

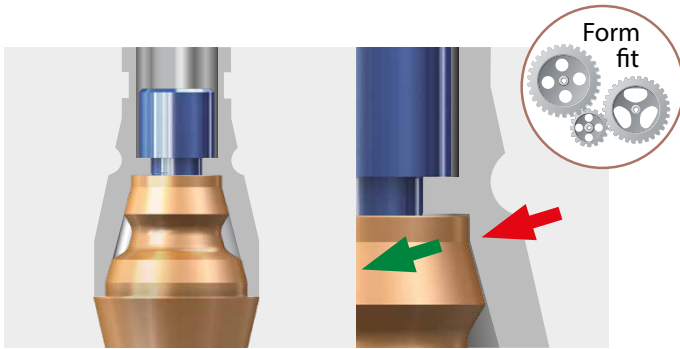

High biomechanical stability of the occlusal screw through Form-Fit, a process that ensures the accuracy of fit with an optimized manufacturing process. The transmission of the lateral forces takes place directly from the bridge to the abutment. The relatively small screw is only slightly loaded and protected against loosening and fracture.

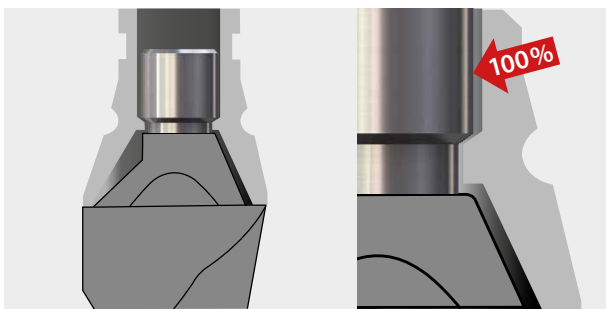

In many competitive systems, the introduction of lateral forces takes place to a large extent via the small screw. High risk of screw loosening and fracture

Unique transversal fixation



The transversal fixation fixes the bridge securely to the abutment over three points. No screw loosening has been observed in 10 years of use.

- The bolt screw always remains in the bridge
- Easy access with screwdriver
- Fasten and loosen in just one turn.
- Safe handling

SKY fast & fixed transversal fixation - lowest possible height

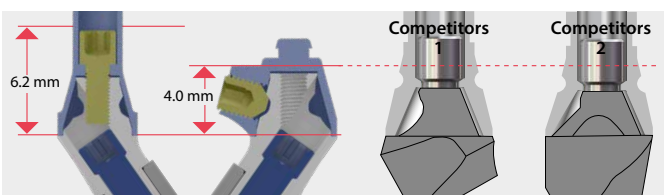

SKY fast & fixed and SKY uni.cone abutments have a relatively high cone for good guidance during insertion. Nevertheless, the transversal fixation enables unrivalled low restorations to be carried out, e.g. for the posterior region..

Free form technology – for better tissue attachment



State-of-the-art production technology produces the angulated abutments in the sulcus region without corners and edges. This gives both bone and soft tissue optimal conditions for attachment.

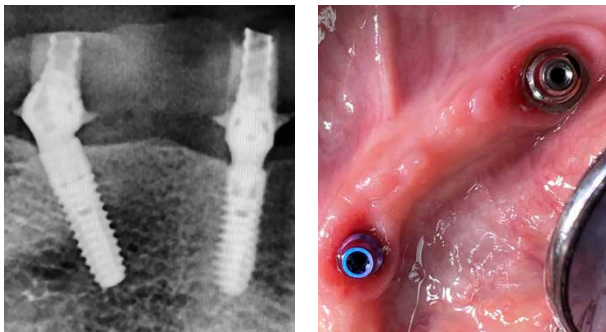

These clinical images with blueSKY and copaSKY implants clearly show the advantages of free form technology for hard and soft tissue, regardless of the SKY implant system selected. Stable bone level and healthy soft tissue.

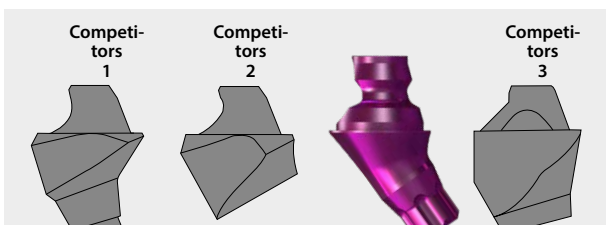

The multi-unit abutments of most competitors are still manufactured with the conventional facet cut, whereby the abutments in the sulcus region are significantly more voluminous and have corners and edges that form predilection points for plaque formation.



The difference can be clearly seen in these X-ray images.

Unique prosthetic solutions

Go digital - successful implementation of the digital workflow

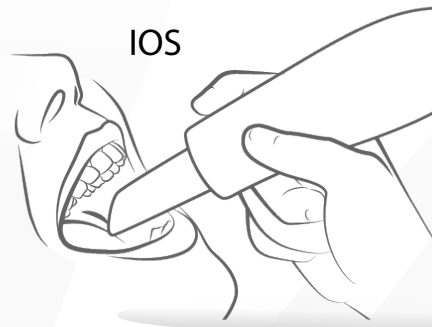

IOS

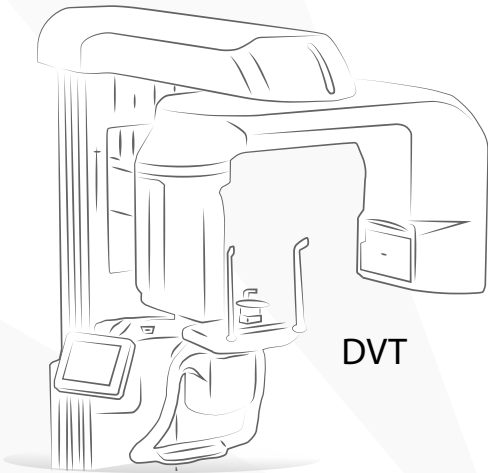

DVT

Guided
implantology



Planning



Milling

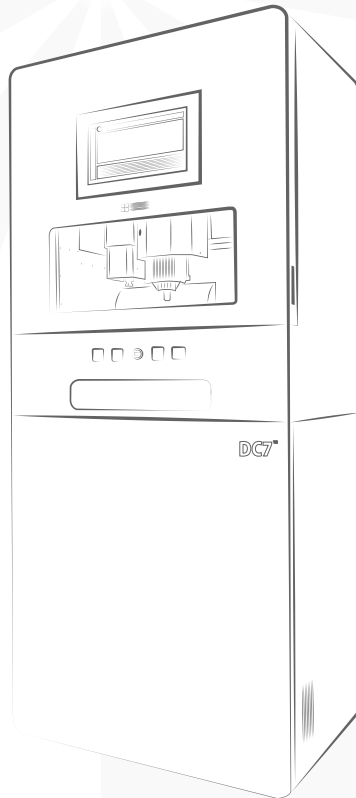



One for all - for guided implantology

The integrated solution for guided implantology with immediate restoration based on physiological materials:

- Shaft guided
- From single tooth to full arch



READY FOR USE

The service platform for digital workflow

CAD/CAM - restorations

Single tooth open systems

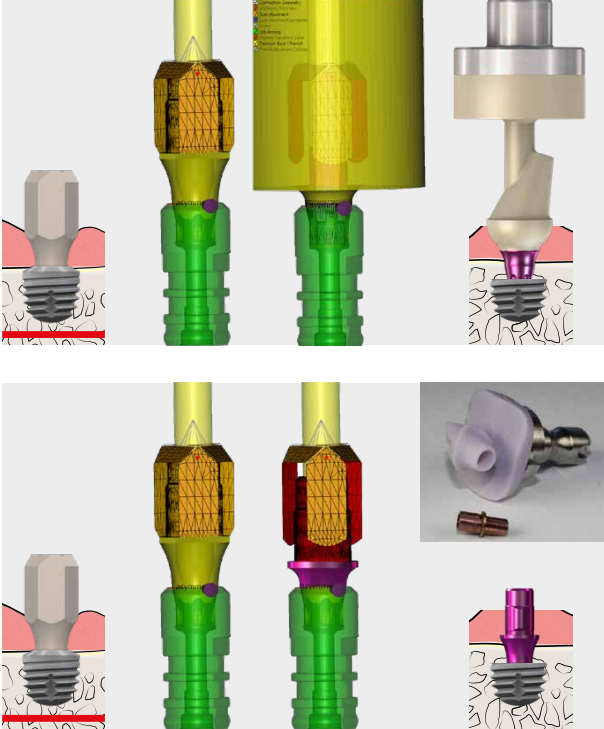

Customized abutments produced in the CAD/CAM process are becoming more and more important. In doing so, we pay great attention to ensuring that the physical components are optimally matched with the virtual components in the various programmes and that work is as convenient as possible.

- Scan abutment from PEEK
- Screw-retained lab analogue for printed models
- Prefabs made of BioHPP with original connection geometry
- Titanium prefabs with original connection geometry
- Titanium base for customised ceramic abutments
- Crowns from HIPC or visio.lign

Single tooth CEREC®

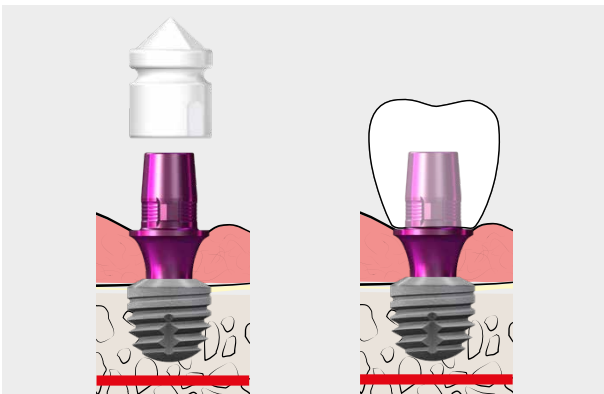

The titanium bases for CEREC have the original geometry of the various SKY implant systems and are compatible with the original Sirona scan bodies, so that they are used in the usual CEREC workflow.

Important: Unfortunately, a suitable alternative implant system must be used when selecting implants in the CEREC library:

- SKY titanium base S - Camlog 3.8 S
- copaSKY titanium base L - BioHorizon 4.5 L
- miniSKY titanium base S - Camlog 3.8 S

Bridge and bar restorations

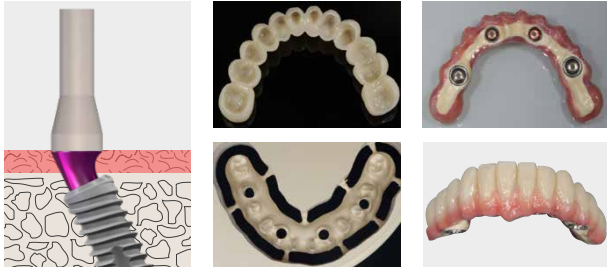

Download the CAD library from:
<https://bredent-group.com/bredent-group-cad-library/>

The bredent group offers a comprehensive programme with unique physiological solutions for bridge restorations of all kinds.

- Scan caps
- Screw-retained lab analogue for printed models
- Physiological and highly stable bridge materials
- Stable and highly aesthetic veneering materials
- Rounds for milled veneers (2-in-1 technology)
- Secure and durable bonding (visio.bond)

Service platform: *READY FOR USE*

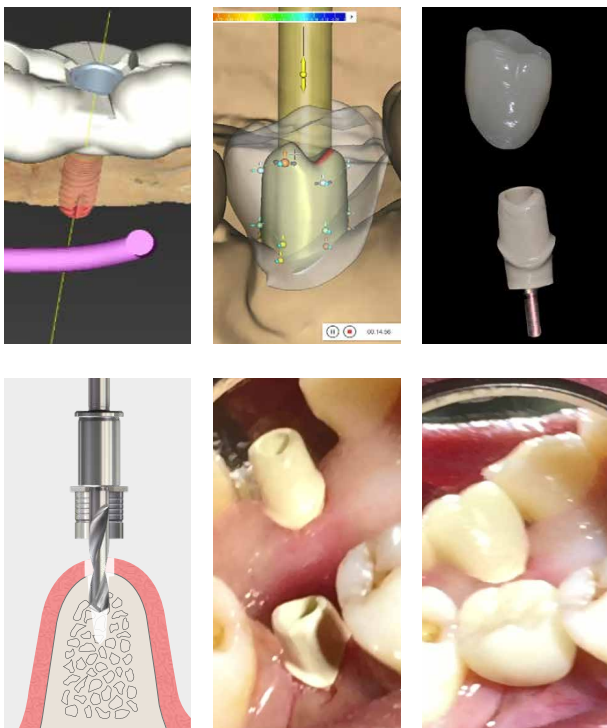

With "Ready for use", you can provide your patients with individual care without any investments. Experienced planning and milling centres support you in this:

- You download DVT/CT data and the intraoral or extraoral scan to the "ready for use platform"
 - Ready for use partner performs 3D planning
 - You approve the planning or make interactive corrections with the partner
 - The partner now produces the drilling template and temporary restoration.
 - You will receive a package containing:
 - Planned implant
 - Proguide drilling template
 - Individual BioHPP abutment and temporary crown
 - You can now place the implant guided with the proguide surgical tray and can immediately restore it
 - The patient leaves the dental practice smiling
- This service is also available for SKY fast & fixed.

We are starting this service in Germany in 2020. The other countries will follow later. Please ask your local supplier when it will be available

Unique prosthetic solutions

50

copaSKY exso multi-function abutment

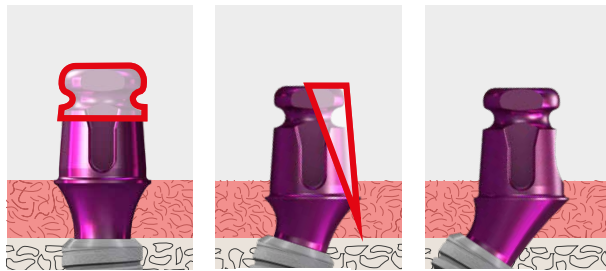
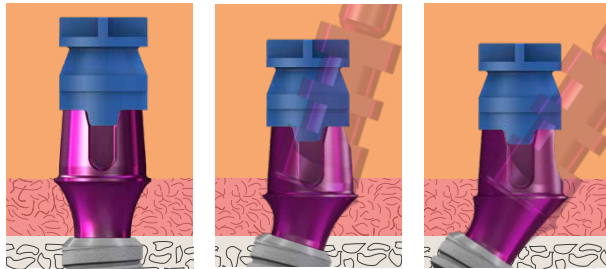
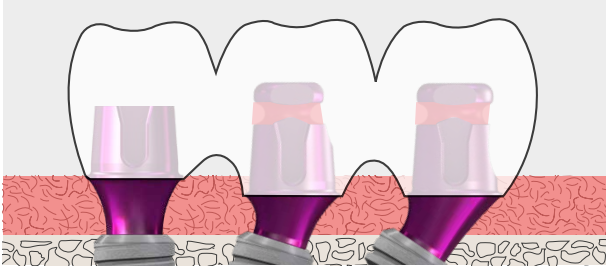

- Cemented crowns and bridge restorations are implemented easily, quickly and aesthetically on SKY exso abutments, the process is highly economical, as impression abutment = definitive abutment

- Easy impression taking of angled placed implants
- at implant level. The angled abutment compensates for the implant angulation. Available in 0°, 17,5° and 35°
- Use of the SKY impression coping for closed trays (REF SKYnPAKA)

- Easy customisation of the abutments in the laboratory create the prerequisites for an optimally designed aesthetic in the abutment area
- In the sulcus area the waisted shape offers optimal conditions for the attachment of soft tissue. The exso Multi-functional abutments cannot be individualized here therefore they are offered in two heights:
 - 1.5 mm
 - 3 mm

copaSKY bridge and bar restorations

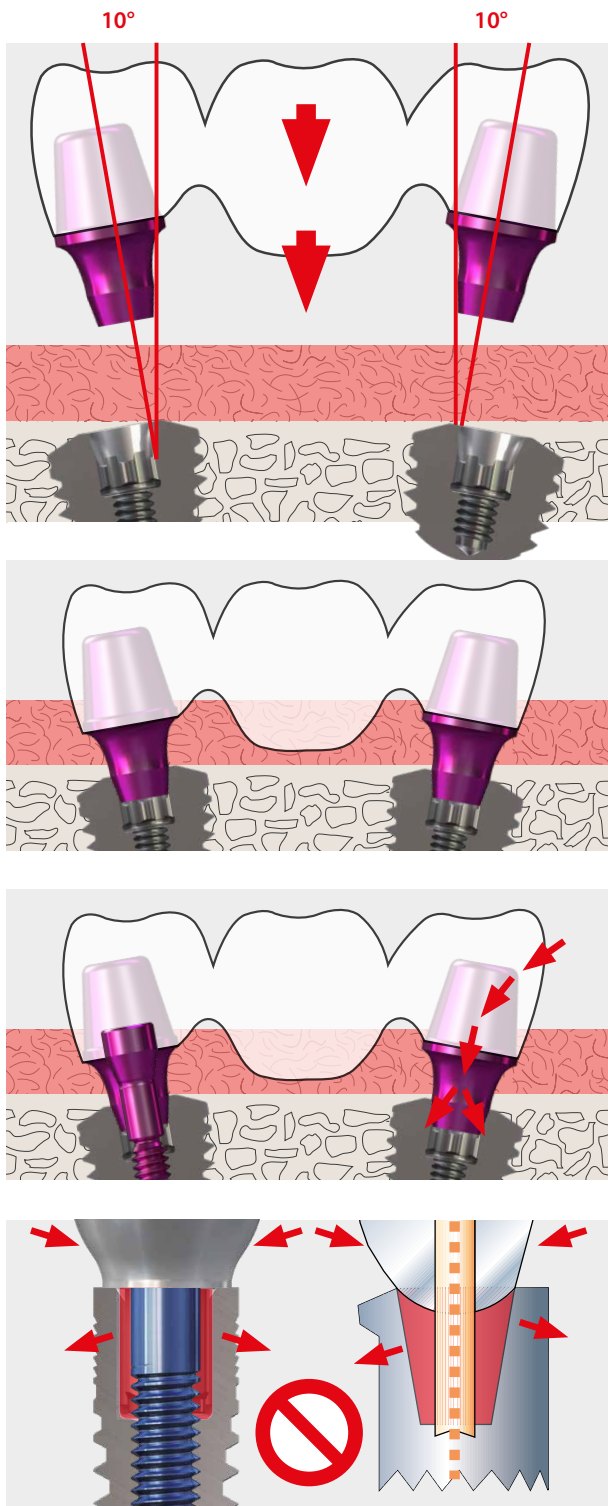

The relatively flat cone of the copaSKY implant enables angulation compensation of up to 20°.

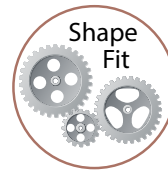

For passive fit we recommend the oral cementation of the framework:

- Conditioning and connection with the Full Range Bonding Kit
- Clean with Fibro+
- Clean and Disinfect according to the FINEVO protocol

For passive fit we recommend the oral cementation of the framework:

- Conditioning and connection with the Full Range Bonding Kit
- Clean with Fibro+
- Clean and Disinfect according to the FINEVO protocol

For tube-in-tube connections, non engaging abutments are not possible because the removal of the anti-rotation connection leads to high forces on the screw, which causes a high risk of screw loosening and fracture. This is also valid for morse taper connections.

Unique prosthetic solutions

Natural chewing sensation due to resilient prosthesis fixation

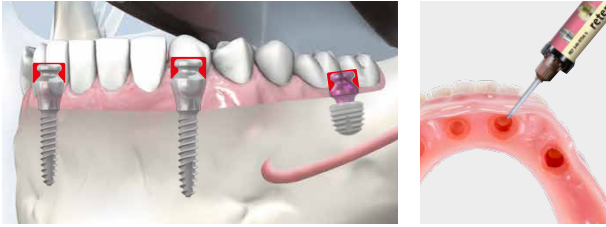

The unique combination of TiSi.snap with the special silicone retention.sil enables permanent prosthesis fixation with high chewing comfort.

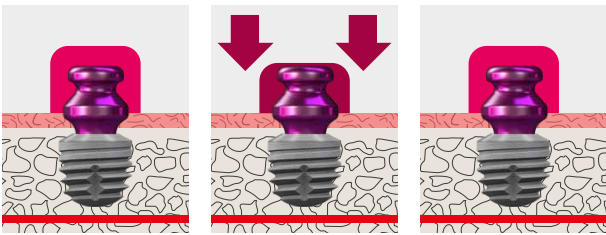

The special silicone retention.sil has a resilience comparable to gingiva. Since the resilient material encloses the TiSi.snap abutment from all sides, the patient has a very pleasant chewing sensation. The mushroom-shaped design of the TiSi.snap abutment ensures a secure hold even with lateral forces that particularly occur in flat jaws.

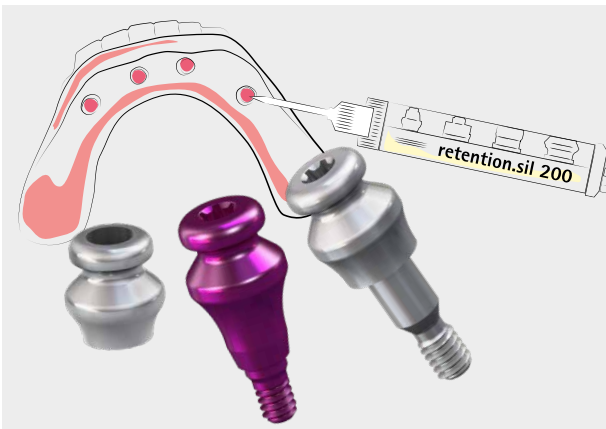

The special silicone retention.sil comes in 3 different strengths:

- retention.sil 200 → Immediate restoration
- retention.sil 400 → 4 implants
- retention.sil 600 → 2 implants

Multisil primer creates a chemical bond between retention.sil and the PMMA, resulting in a durable bond that lasts for up to 5 years.

TiSi.snap abutments are also compatible with the 10°-20° locator retention elements.

Cleanliness



The cleanliness of the implant surface is an important factor in the production process, as organic and inorganic residues compromise implant success.

During the manufacture of our implants, great care is therefore taken with regard to cleaning:

- After turning the implants, a multi-stage cleaning process takes place to remove all oil and coolant residues
- After the implants have been blasted all jet residues are carefully removed from the surface in a multi-stage process
- After etching the implants all acid residues are removed in a multi-stage process
- Storage and transport takes place in validated containers

In a study carried out by the independent Clean Implant Foundation® in Berlin, the effectiveness of our production and cleaning process was confirmed using the example of blueSKY.

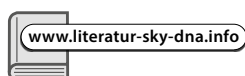
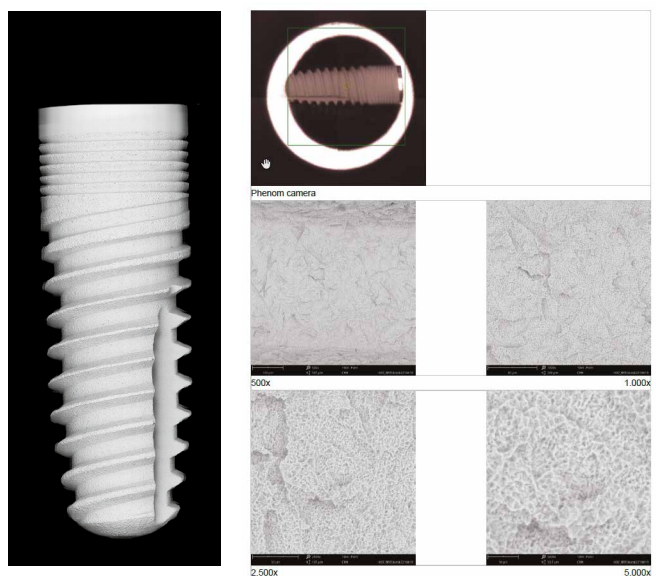

HELBO therapy for preparation of implantation/augmentation

Areas of application

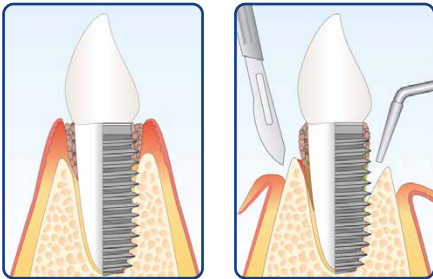

Periodontitis / Periimplantitis
(closed/surgical procedure)

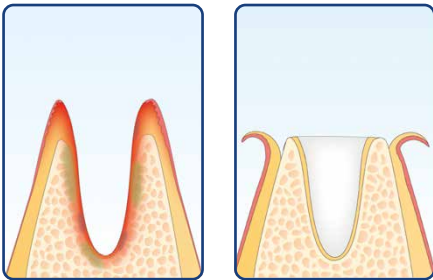

Disinfection
of the alveoli

Socket preservation

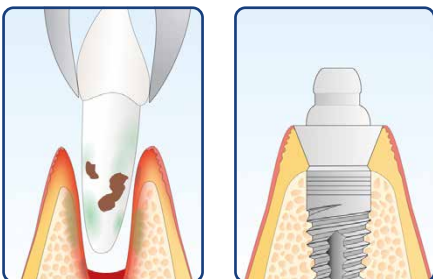

Disinfection
of the alveoli

Immediate
implantation

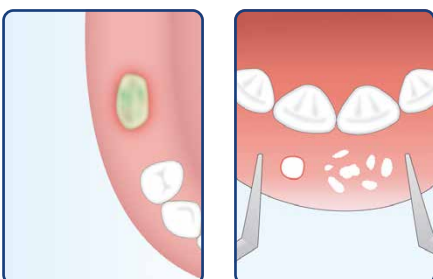

Bone necrosis

Tissue repair
disorders

Inflammation in the oral cavity can endanger surgical procedures and the success of implantations and augmentations or result in complications.

Therefore, for example,

- periodontal or periimplant disorders are treated in advance of such a planned measure.
- Disinfect extraction alveoli before immediate implantation or before augmentation ("socket preservation").

With HELBO therapy bacteria can be effectively controlled preventively, intra-operatively and post-operatively.

Tissue repair issues and temporary inflammations that occur can be successfully treated and therefore the therapy result can be permanently secured, in particular if interventions are taken as early as possible within the scope of the recommended recalls.

The therapy can be repeated as often as required there is no risk of resistance formation.

The use of sterile products guarantees maximum hygiene protection.

HELBO therapy to ensure therapy success

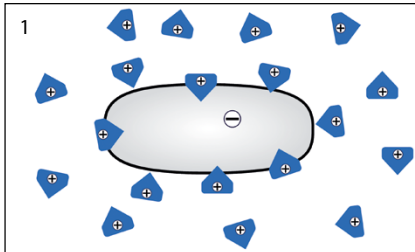

1 Accumulation of light-sensitive photosensitizers on the bacterial membrane

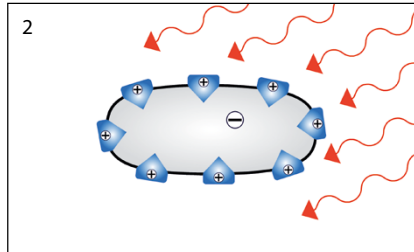

2 Exposure and stimulation of the photosensitizers with the HELBOTHERALITE Laser

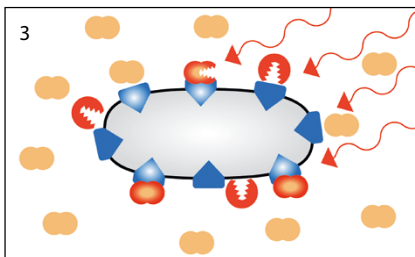

3 Reaction with oxygen, image of aggressive singlet oxygen

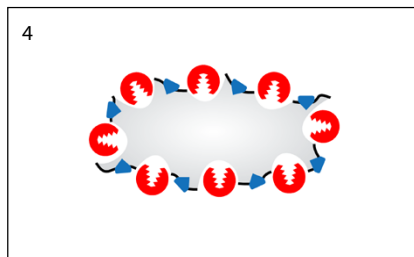

4 Damage to bacterial membrane: destruction of the micro-organisms

How HELBO therapy works in 4 steps:

1. A sterile, light-active dye solution (“photosensitizer”) is applied atraumatically into the problem zone.
2. An exposure time of 1-3 minutes (depending on the indication and severity of the disease) allows the dye molecules to stick to the bacterial walls, even in existing biofilm.
3. Activation with special laser light results in a reaction with oxygen from the environment and forms so-called singlet oxygen.
4. This form of oxygen is very aggressive and damages bacterial walls irreversibly. Bacteria is destroyed, inflammation is controlled- minimally invasive and without side effects.



Antimicrobial photodynamic therapy as substitute for systemic antibiotics in immediate implant placement following ligature-induced periodontitis

Arthur B. Novaes Jr.; Umberto D. Ramos; Valdir A. Muglia, Adriana L. G. De almeida, Carolina M. R. Mandetta



PD012

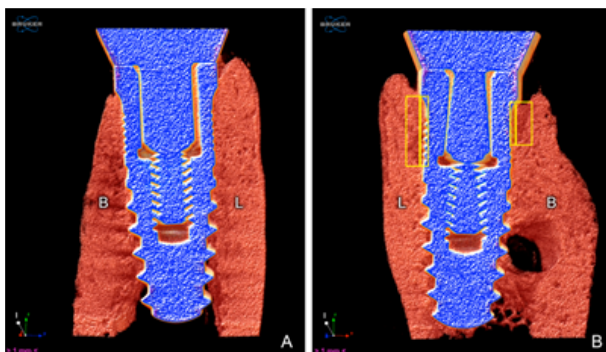

Summary:

"Immediate implants implanted in periodontally infected extraction alveoli treated with antimicrobial photodynamic therapy showed significantly better bone quantity and quality compared to extraction alveoli treated with debridement in conjunction with saline irrigation. It can therefore be concluded that previously contaminated alveoli treated with aPDT effectively result in better bone formation around immediately placed implants than mechanical treatment alone."

FINEVO - Are your custom-made abutments clean?

The problem



SEM images of the submucosal area of a hybrid abutment.

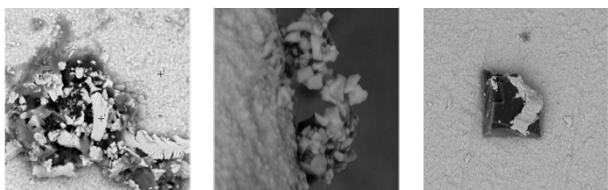

Process-related impurities with CAD/CAM abutments
 Impurities on the surface are recognisable. The image shows pronounced impurities after bonding. These embedded impurities can only be removed with a coordinated processing protocol and subsequent ultrasonic cleaning.

Comparison: Before and after the FCS cleaning

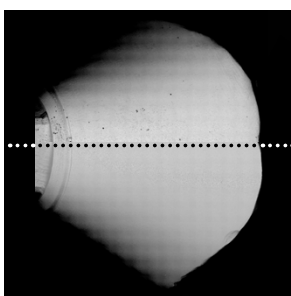

BEFORE
Significant impurities
 on zirconium abutment

AFTER
 Zirconium abutment
without contamination
 after correctly performed
 abutment surface machin-
 ing protocol and subse-
 quent cleaning (FCS)

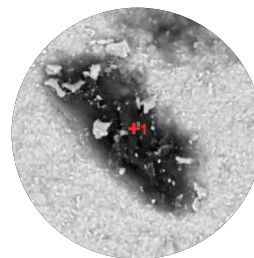

Summary of the cleaning
 on zirconium CAD/CAM
 abutment

Carbon	25.17
Oxygen	20.82
Nitrogen	8.42
Zirconium	39.65
Yttrium	3.91
Sulphur	1.20
Silicon	0.83

The solution

FINEVO



The FINEVO and Fibro+ protocol

Support the formation of a closed gingival seal to protect against periimplantitis and allergies by optimally cleaning individually manufactured abutments.

- Scientifically proven to remove contaminants such as processing residues, greases and oils down to the nanoscale (see SEM images) from the surfaces, minimizing the risk of infections and allergies
- Time-saving cleaning process can be integrated or delegated into the usual workflow
- 3-bath system as a protocol contributes to eliminating errors
- Ready-to-use liquids facilitate the application in laboratories and practices
- The protocol can be documented and hence ensures increased reliability for the dentist



Fibro+

- Produces the surface roughness (0.21 to 0.4 µm) required for optimum fibroblast deposition. These surface tools are used for "fibro polishing" of metals, ceramics and zirconium
- Due to its special composition, Fibro+ does not leave any residues and hence perfectly prepares for FINEVO fine cleaning by "coarse cleaning"

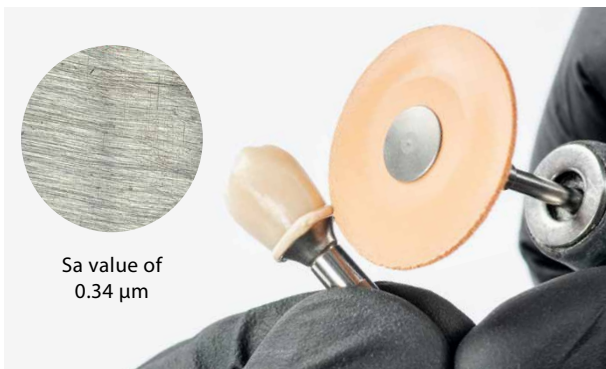

Full Range Bonding Kit

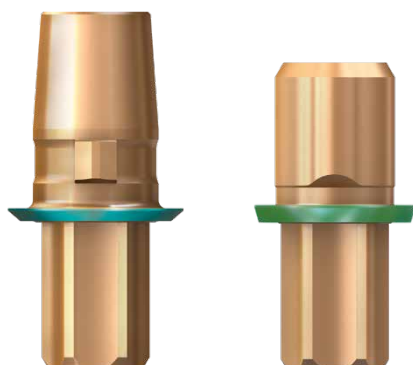

The neat solution for all prosthetic materials

Simple and safe cleaning is ensured by the application of FGP insulation varnish on the parts to be bonded. Areas of inflammation due to adhesive residues are a thing of the past.

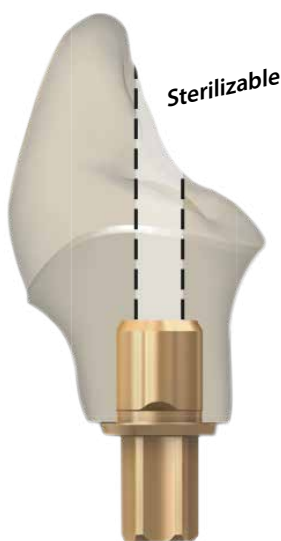

Full Range Bonding Kit

Primer for all prosthetic materials

- Titanium, zirconium, NPM – MKZ primer
- Ceramic, lithium disilicate – K primer
- PMMA, composite, BioHPP – visio.link

DTK adhesive

- Opaque (colour A2 / A3) for bonding titanium bases with ceramic abutments or crown abutments – no dark shadows impair the result
- Transparent for bonding ceramic abutments and crowns – no impairment of the translucence.

bredent REF 5400BOND

bredent medical REF 5800BOND

Chipping repair kit



Following repair with crea.lign composite

Chipping cases treated quickly and easily

- Primer works in conjunction with any prosthetic materials
- crea.lign Incisal and Dentin materials (in A2 and A3 suitable for 80% of all cases)
- No hydrofluoric acid required"

Chipping Repair Kit for Dentists
REF CLIGNSETA

contains crea.lign composite in colours A2/A3 including 4 primers and consumables.



Intraoral application

- "mouth approved": approved for intraoral application
- Chipping repair for all veneer materials
- "What you see is what you get": result is immediately visible and adjustable - no firing required
- Rapid repair in situ:
direct and simple

Permanent repairs with no loss of quality

- Material is approved for permanent repairs
- No loss of aesthetics: no colour differences and no "repair transitions" can be detected
- No loss of mechanical properties
- The result is at "supra-ceramic level"

Tools and instruments

CPS Cordless Prosthodontic Screwdriver

How much time do you spend loosening and fixing implant screws?

You can save app. 50 % of the time using the CPS.

Are you sure that your screws are always the correct tightness?

With CPS there will be no screw loosening due to wrong torque.

Can you reach your palatal screws easily?

With CPS you have perfect access to all sites because it is cordless.

Perfect Handling

- cordless
- ergonomic design

Highest precision

- Precision of torque values +/- 5%
- Torque range: 8 Ncm – 40 Ncm



Best hygiene

- Non-slip handpiece and removable switch
- autoclavable
- thermo-disinfectable

Universal

With screwdrivers for the most important implant systems

CPS Cordless Prosthodontic Screwdriver

+ Full Range Driver-Kit

REF 580CPS40



Full Range Driver Kit

Hexagon (Inch)	0.03	0.05			
Hexagon (mm)	0.9	1.0	1.2	1.8	2.5
Torx (mm)	SKY	5.5	6.0		
Slot (mm)	1.6	2.0			

Full Range Driver Kit

These tools always fit

Universal: Can be used for prosthetic screws from the most common manufacturers on the market

Hygienic: Validated sterilisation and preparation process (corresponds to the RKI guidelines)

Practical: In the thermo disinfectant, the instruments stay in the tray during cleaning

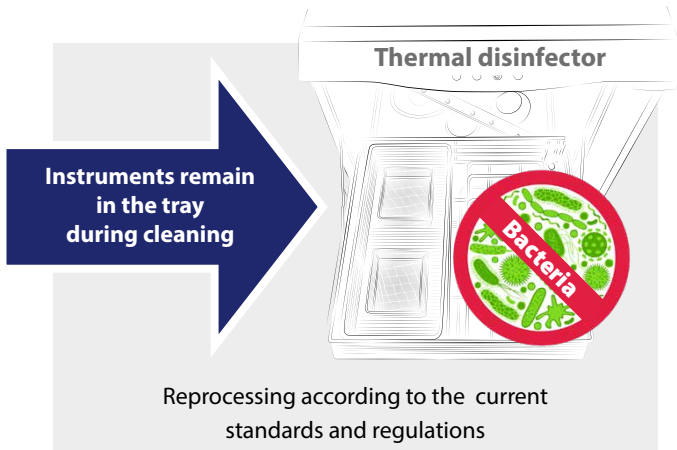

A good range*
The basic kit offers you a selection of the most common tools for daily use.

Hexagon (Inch)	0.03	0.05			
Hexagon (mm)	0.9	1.0	1.2	1.8	2.5
Torx (mm)	SKY	5.5	6.0		
Slot (mm)	1.6	2.0			

*contains contra-angle instruments in the long version

Measuring device for implant stability – bredent Penguin^{RFA}



- ✓ *non-invasive*
- ✓ *objective*
- ✓ *reproducible*
- ✓ *precise*



1 With the so-called "Driver", the MulTipeg™ is screwed into the implant or the abutment.

2 The MulTipeg™ begins vibrating as a result of short magnetic impulses from the tip of the bredent Penguin^{RFA}. The magnetic impulses interact with the magnets in the inside of the measuring pin.

3 A receiver in the bredent Penguin^{RFA} calculates the ISQ value (= Implant Stability Quotient). This value is displayed after a few seconds.



The ISQ value is a measure of the stability of the implant - the higher the value, the more stable the implant is. We recommend:

- **> 70 ISQ**
immediate restoration possible
- **55 - 70 ISQ**
blocked immediate restoration
- **< 55 ISQ**
implant should heal covered

*Sennerby L Prof., Implantologie [Implantology] 2013; 21(1): 21-23

MulTipeg™

The MulTipeg™ is available in four different sizes and makes it possible to measure primary stability in virtually all SKY implant system implants.

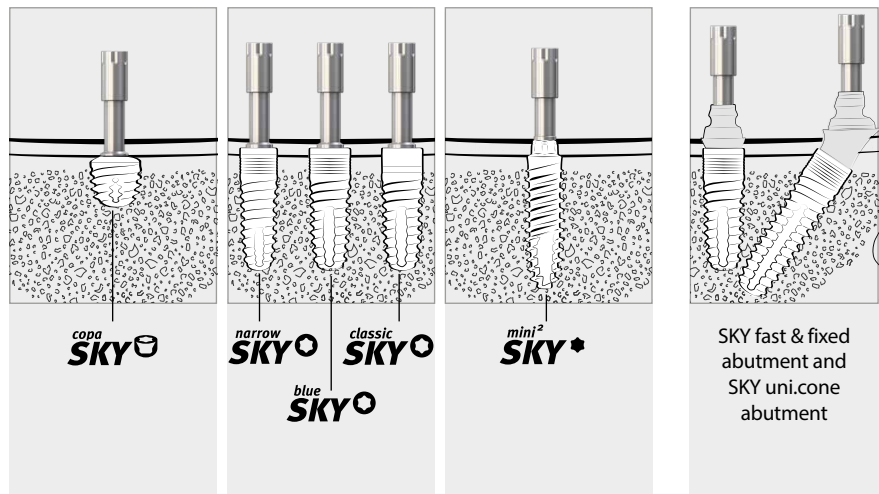

System overview



MulTipeg™
copaSKY
REF 580MPCOP

MulTipeg™
SKY, blueSKY,
narrowSKY,
SKYclassic
REF 580MPSKY

MulTipeg™
mini²SKY
REF 580MPMI2

MulTipeg™
fast & fixed
abutment level
REF 580MPFFA

Instrument Kit



Penguin^{RFA}
Instrument Kit
REF 580PENGU

brendent
Penguin^{RFA}

MulTipeg™
Driver

Charging cable

Sterile cover



Penguin^{RFA} Cover
1 set (20 pieces)
REF 580PENG

***bre*dent group Academy**

Learn:

- What new techniques and therapies are developing and finding their way into the practice of the dental practitioner and dental technician?
- Which of the bre^{dent} group's existing, successful therapy concepts "suits" me and my dental practice?
- How can I successfully integrate such a concept into my daily work?
- We will give you guidance with our bre^{dent} group Academy training programme with courses for the entire treatment team - dentists, implantologists and dental assistants - and also for the dental technology sector which is the origin of the bre^{dent} group's dental success story. We are supported by renowned speakers from dental practices and laboratories who ensure the connection to your daily work.



www.bredent.com



bre^{dent} group
Dental courses

bre^{dent} group
Dental courses

**System consulting
Product training**

Work shadowing

**Presentations
Symposia
Congresses**

IFZI – Internationales Fortbildungszentrum für Zahnärztliche Implantologie

The independent IFZI Training Institute in Nuremberg works closely with the bredent group. The modular advanced training concept of the IFZI is highly practical and provides every beginner with the necessary assurance to successfully integrate implantology into their own dental practice. With more than 20 years of experience providing qualified and certified, postgraduate implantology education and training for dentists, first-class instructors and a professional team, IFZI will be with you before, during and after the course until you reach implantology independence.



www.ifzi.de

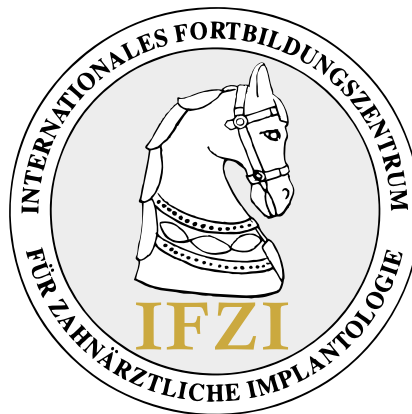

Basic implantological training on the surgical simulator

Live surgery under supervision

Surgical assistance

Advanced course in surgical techniques and implant prosthetic restorations

**Special modules
Bone splitting & condensing, immediate restoration, PRGF technology, piezosurgery**

Implantological curriculum

SKY implants for a lifetime

Each lost SKY implant is replaced free of charge

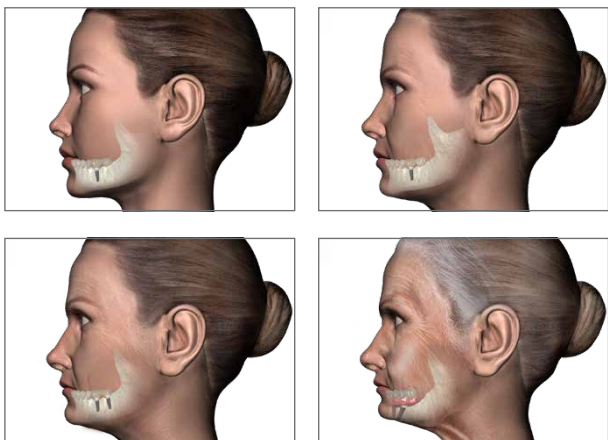

implants minus replaced implants

Since 2007 bredent medical replaces each lost SKY implant to give you the possibility to replace it. You will receive a new implant without any bureaucratic effort.

We only need:

- documentation sheet (2 pages)
- X-ray image of the treatment (data protected)
- Lost implant

Prosthetic components:

We replace non-functioning prosthetic components in an unbureaucratic manner. A brief description of the fault (except for normal wear and tear) and sending of the damaged component is sufficient.

The rate of technical faults in prosthetic components is 0.18% - based on 2.3 million prosthetic parts

SKY implants success rate

Sold implants minus replaced implants

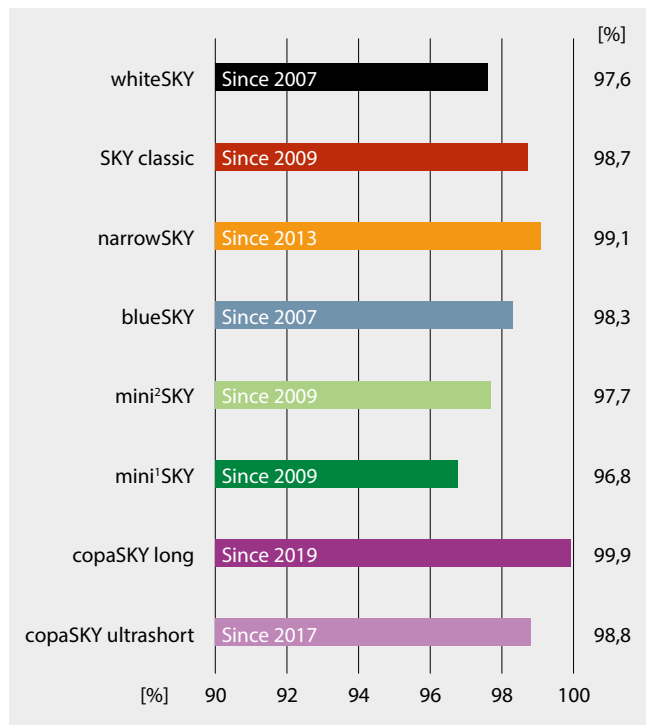

The success rate is calculated from the number of implants sold minus the number of lost implants.

Version: July 2020

Basis: 1.3 million implants sold

Based on the analysis of the warranty cases, the success rate of standard SKY implants is over 98%, the differences are not significant.

copaSKY ultrashort has a pleasingly low number of warranty cases after 3 years if you compare this with results from the literature.

The increased rate of miniSKY is primarily due to incorrect use of implants with a diameter of 2.8 mm.

- Use in the upper jaw is contraindicated
- Use with teeth in the opposing jaw is contraindicated

With whiteSKY, we observe a slightly increased rate of implant losses during the healing phase. Particular attention must be paid here to the design of the temporary restoration. A once osseointegrated whiteSKY implant is rarely lost.

Download: www.bredent.com
or order a brochure

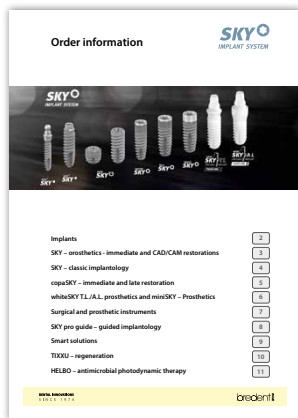

Order information as an
interactive PDF file to
order directly by e-mail
REF 0091009GB

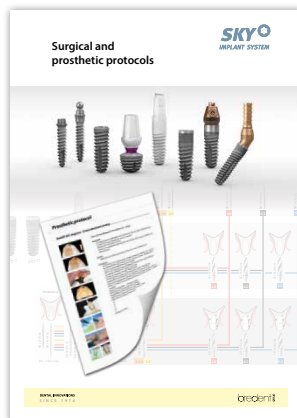

Surgical and
prosthetic protocols
REF 0091040GB

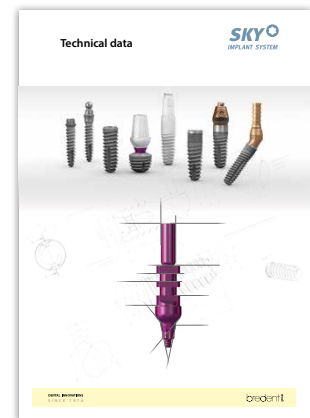

Technical data
REF 0091008GB

000250GB-20210920 Mistake and subject to change reserved

